

Product Brochure For C4064

Foot Swivel Caster Wheel - 1 Piece - GD-80F

500kg Load Capacity

On Sale

Ex GST

Inc GST

~~\$24.00~~

~~\$26.40~~

\$20.00

\$22.00



ORDER CODE:	C4064
MODEL:	GD-80F
Quantity of Wheels in Pack (No.):	1
Wheel Type:	Foot Swivel Caster Wheel - Adjustable Stop
Wheel Diameter (mm):	63
Wheel Width (mm):	28
Total Height to Top of Plate (mm):	103
Load Capacity per Wheel (kg):	500
Load Capacity per Set (kg):	~
Nett Weight (kg):	1.04



Features





- Suitable for Welding Tables
- Swivel Wheel Mount Bracket
- Adjustable Stop with Integrated thumb spanner for height adjustment
- Anti-vibration NBR foot pad
- 500kg Load Capacity

Includes

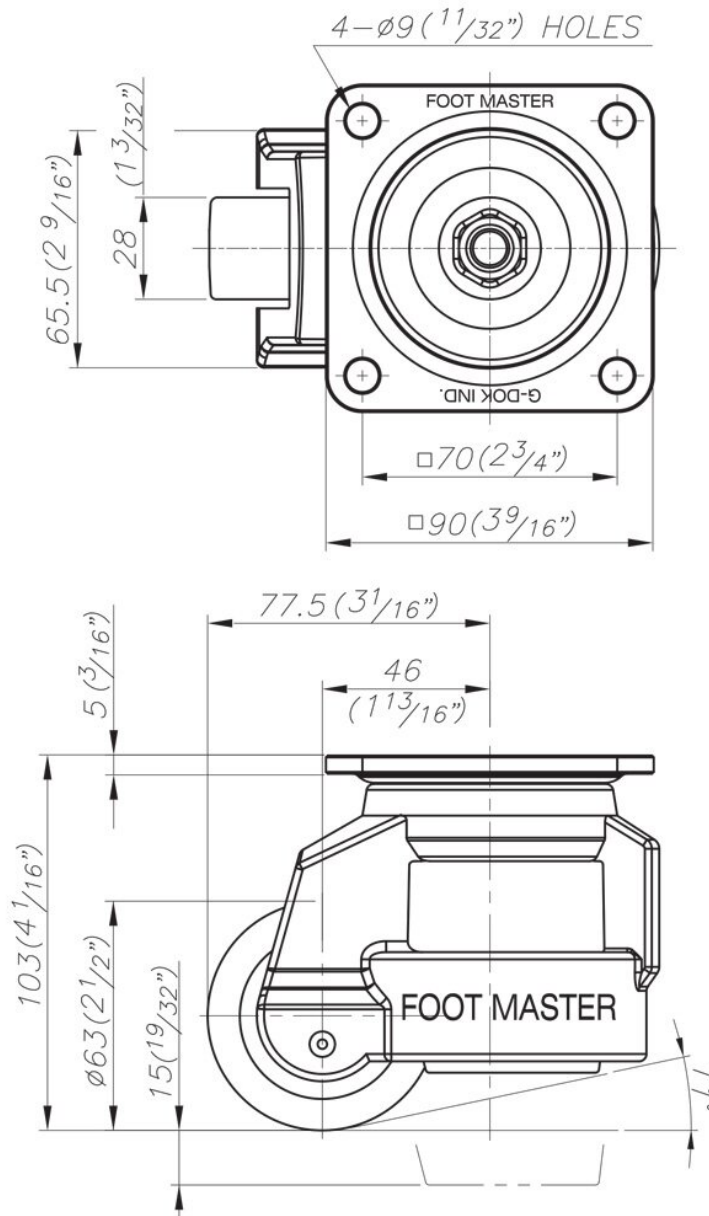
- 1 Piece

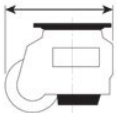
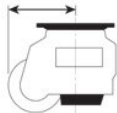
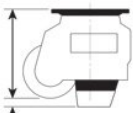
GD-80F - Dimensions



MODEL	Load Capacity / pce kg	 mm	 mm	 mm	 mm	 mm	 mm
GD-80F	500	125	77	102+15	92x92	70x70	9

Product Brochure For C4064

Specific Features



Ajustable Stop Wound Down



Ajustable Stop Wound Up

Recommended Accessories

W07742

BuildPro HD Table Leg - 1 Piece



W07720A

2560 x 1250mm BuildPro Modular Welding Table - Standard Finish



W07716A

1960 x 1000mm BuildPro Modular Welding Table - Standard Finish



W07712A

1160 x 1000mm BuildPro Modular Welding Table - Standard Finish



W07749

BuildPro Levelling Pad for Tabletop - 1 Piece

