

Product Brochure For C4068

Foot Swivel Caster Wheel - 1 Piece - GD-120F

1000kg Load Capacity

On Sale

Ex GST

Inc GST

~~\$36.00~~

~~\$39.60~~

\$30.00

\$33.00



ORDER CODE:	C4068
MODEL:	GD-120F
Quantity of Wheels in Pack (No.):	1
Wheel Type:	Foot Caster Wheel - Adjustable Stop
Wheel Diameter (mm):	75
Wheel Width (mm):	30
Total Height to Top of Plate (mm):	120
Load Capacity per Wheel (kg):	1000
Load Capacity per Set (kg):	~
Nett Weight (kg):	1.6



Features

- Suitable for Welding Tables
- Swivel Wheel Mount Bracket
- Adjustable Stop with Integrated thumb spanner for height adjustment
- Anti-vibration NBR foot pad
- 1000kg Load Capacity

Includes

- 1 Piece

GD-120F - Dimensions

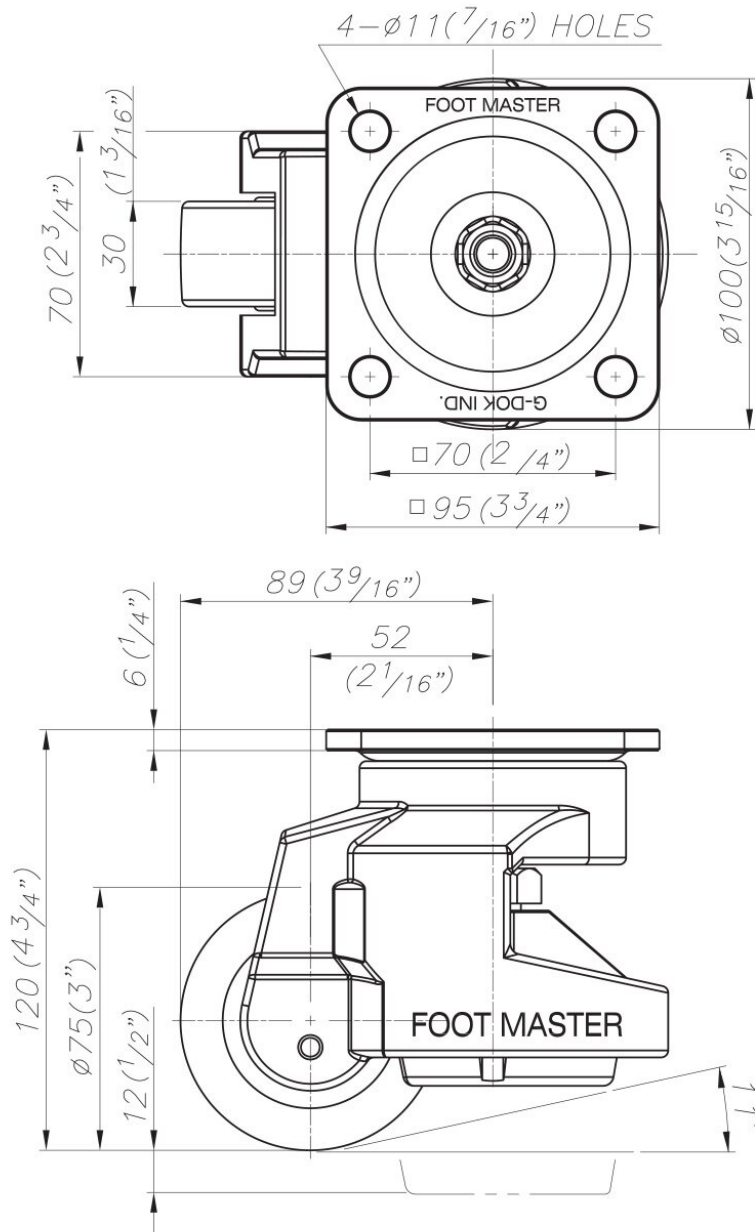

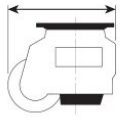
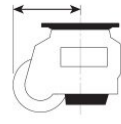
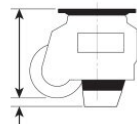
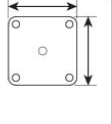
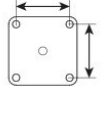
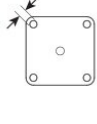
MODEL	Load Capacity / pce kg	 mm	 mm	 mm	 mm	 mm	 mm
GD-120F	1000	141	89	120+12	95x95	70x70	11

Product Brochure For C4068

Specific Features



Ajustable Stop Wound Down



Ajustable Stop Wound Up

Recommended Accessories

W07742

BuildPro HD Table Leg - 1 Piece



W07720A

2560 x 1250mm BuildPro Modular Welding Table - Standard Finish



W07716A

1960 x 1000mm BuildPro Modular Welding Table - Standard Finish



W07712A

1160 x 1000mm BuildPro Modular Welding Table - Standard Finish



W07749

BuildPro Levelling Pad for Tabletop - 1 Piece

