

Product Brochure For C412

Industrial Caster Wheels - CW-125S

Ø125mm Wheels
 2 x Swivel/Brake



On Sale

Ex GST

~~\$80.00~~

\$67.27

Inc GST

~~\$88.00~~

\$74.00

ORDER CODE:	C412
MODEL:	CW-125S
Quantity of Wheels in Pack (No.):	2
Wheel Type:	2 Swivel/Brake
Wheel Diameter (mm):	Ø125
Wheel Width (mm):	50
Total Height to Top of Plate (mm):	165
Load Capacity per Wheel (kg):	410
Load Capacity per Set (kg):	820
Nett Weight (kg):	8



Description

Industrial quality & Ø125mm castor wheels, Tyre is made from tough elastic rubber with an load capacity of up to 410kg per castor.

Features

- Ø125mm x 50mm wide steel wheel with bonded polyurethane
- 2 x swivel wheels with brake
- 410kg each wheel capacity
- Brake also locks wheel from swivelling
- Swivel base incorporates ball bearings
- Ball bearing sealed race on main shaft
- 165mm overall height from base of wheel to top of plate
- Mounting plate 114 x 102mm with 4 slotted holes

Product Brochure For C412

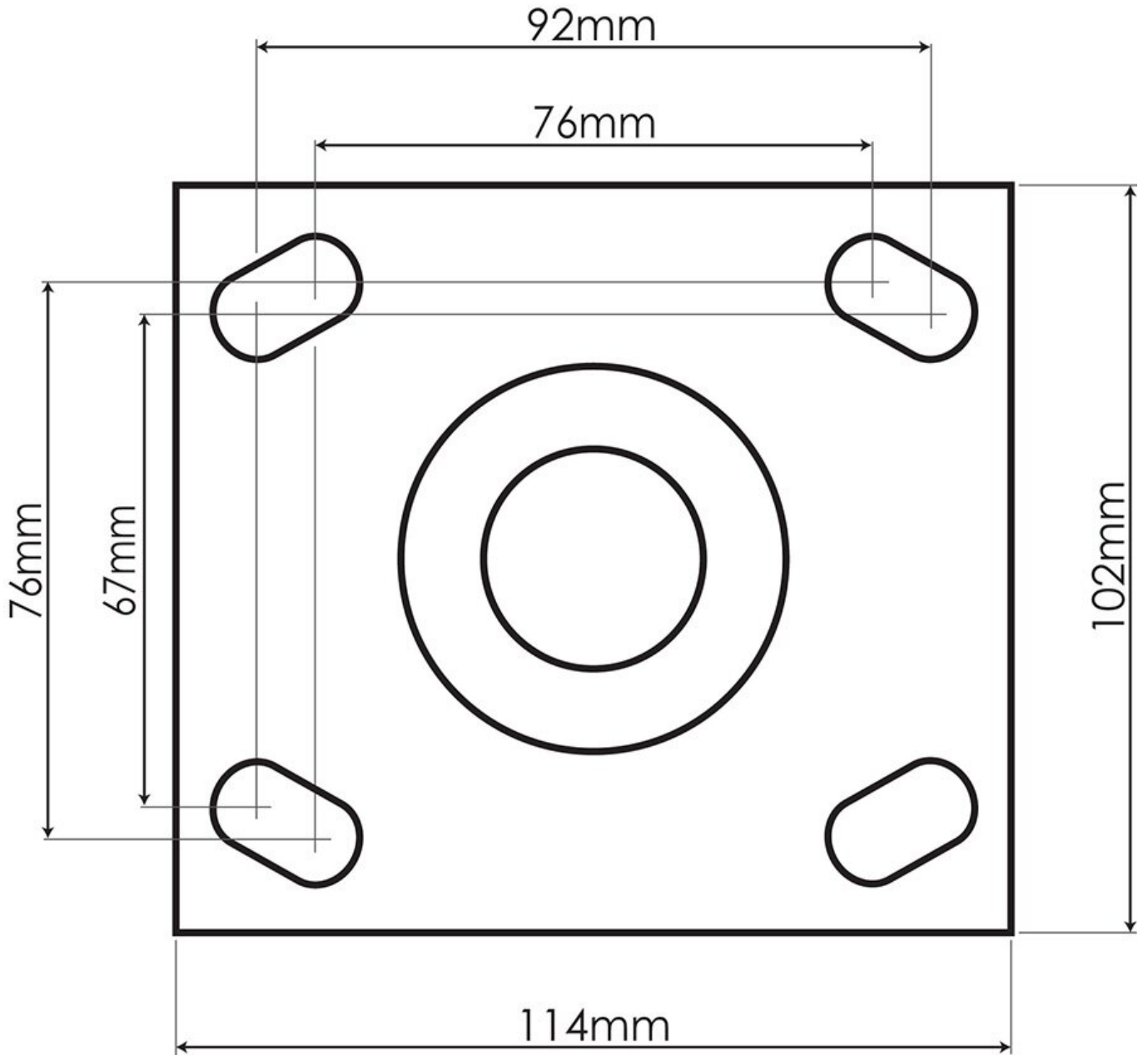

Product Brochure For C412

Specific Features



Foot Brake Activated



Foot Brake Released



Top View



Ball Bearings Base with Greasing Nipple



Foot Brake With Swivel Base Lock

Recommended Accessories

A380
Steel Work Bench - 3 x Lockable
Drawers

