

Product Brochure For C8437

## ER20 Collet

Ø9-Ø8mm

"Made in Taiwan"



**On Sale**

Ex GST

~~\$18.00~~

**\$15.45**

Inc GST

~~\$19.80~~

**\$17.00**

ORDER CODE:	C8437
Type:	ER20
Metric Size (mm):	9 - 8
Imperial Size (inch):	~



### Features

- Manufactured to DIN standard
- Collet size covers a range from expanded to compressed
- Collets from 2mm have 1mm of movement
- Collets are listed by their expanded size
- Eg. When ordering an ER32-3 the range is from 3mm expanded to 2mm compressed

Product Brochure For C8437

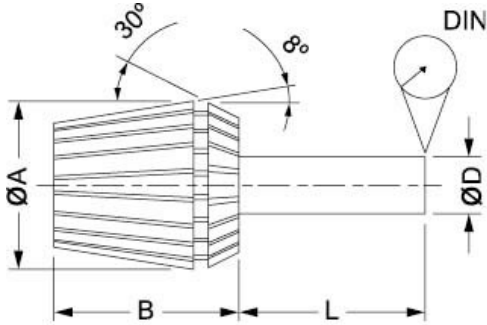

Collet	A	B	L	DIN	RANGE (D)
ER11	11.5	18	6	0.02	0.5-7.0
ER16	17	27	10	0.02	0.5-10.0
ER20	21	31	16	0.02	1.0-13.0
ER25	26	35	25	0.02	1.0-16.0
ER32	33	40	40	0.02	2.0-20.0
ER40	41	46	50	0.03	3.0-26.0

**Installation Guide** - Please see downloads for full details

**1.**

**2.**

**3.**

