

Product Brochure For C937

ER40 Collet

Ø7-Ø6mm

"Made in Taiwan"



On Sale

Ex GST

~~\$25.00~~

\$20.91

Inc GST

~~\$27.50~~

\$23.00

ORDER CODE:	C937
Type:	ER40
Metric Size (mm):	7 - 6
Imperial Size (inch):	~



Features

- Manufactured to DIN standard
- Collet size covers a range from expanded to compressed
- Collets from 2mm have 1mm of movement
- Collets are listed by their expanded size
- Eg. When ordering an ER32-3 the range is from 3mm expanded to 2mm compressed

Product Brochure For C937

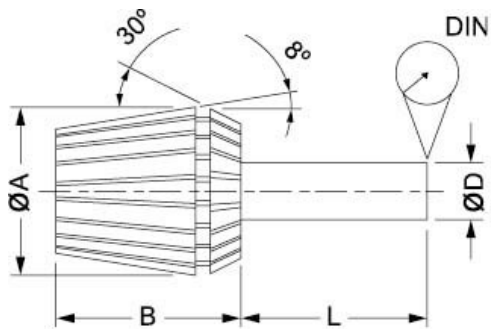

Collet	A	B	L	DIN	RANGE (D)
ER11	11.5	18	6	0.02	0.5-7.0
ER16	17	27	10	0.02	0.5-10.0
ER20	21	31	16	0.02	1.0-13.0
ER25	26	35	25	0.02	1.0-16.0
ER32	33	40	40	0.02	2.0-20.0
ER40	41	46	50	0.03	3.0-26.0

Installation Guide - Please see downloads for full details

1.

2.

3.

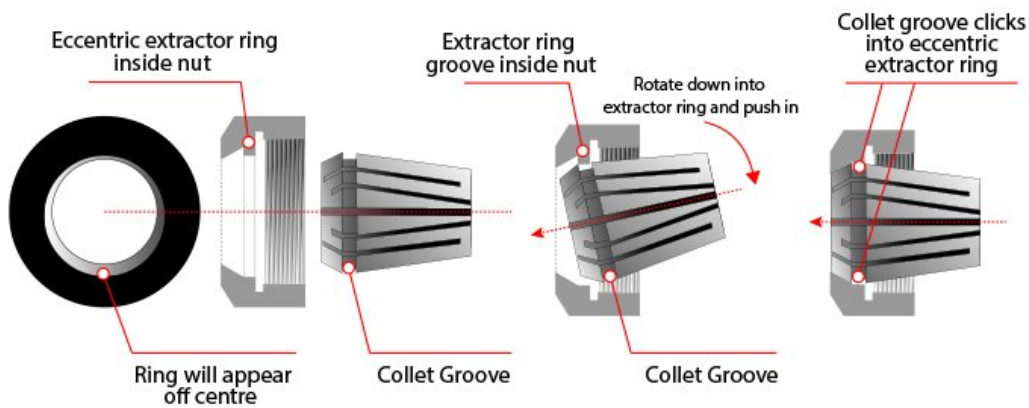

Recommended Accessories

C957
ER40 Collet Set - 7 Piece

C958
ER40 Collet Set - 23 Piece

C959
Collet & Chuck Set - 9 Piece

C963
Collet & Chuck Set - 25 Piece



Product Brochure For C937

C960
 Collet & Chuck Set - 9 Piece



C961
 Collet & Chuck Set - 9 Piece



C962
 Collet & Chuck Set - 9 Piece



C964
 Collet & Chuck Set - 25 Piece



C965
 Collet & Chuck Set - 25 Piece



C966
 Collet & Chuck Set - 25 Piece



C967
 Collet & Chuck Set - 25 Piece



C138
 Collet Chuck R8 x ER40



C111
 Collet Chuck - NT30 x ER40



C114
 Collet Chuck NT40 x ER40



T226
 BT40 x ER40-80 Collet Chuck



T228
 BT40 x ER40-100 Collet Chuck



Product Brochure For C937

T450

BT50 x ER40-100 Collet Chuck

