

Product Brochure For D721

250mm Easson Digital Readout Scale

VS10 Standard Scale
 5µm Resolution



Ex GST
\$200.00

Inc GST
\$220.00

ORDER CODE:	D721
MODEL:	~
Type:	VS10 Standard Scale
Travel - Maximum (mm):	250
Overall Length (L) (mm):	396
Scale Resolution (µm):	5
Grating Pitch:	~
Accuracy (µm):	±3 - ±5
Output Signal:	~
Connector:	~
Cable Length (Metre):	3
Working Temperature (°C):	~
Sealing Protection Class:	~
Maximum Speed (M/min):	~
Reference Point:	~
Width x Height (W x H) (mm):	27.5 x 3.5
Backing Support Plate (Yes / No):	Yes



Description

Easson VS series Glass Grating Linear Transducer: EASSON - Always committed to Quality, Technology & Innovation

Features

- **DOUBLE SEAL DESIGNED SCALES:**
- The plastic seals of the transducer use an innovative material to offer superior oil resistance, high elastic recovery properties and durability, carefully designed lip geometry offer low slide resistance.
- **100% LASER CALIBRATION:**
- All glass grating transducers are individually inspected and calibrated by our in-house laser calibrator to ensure accuracy complies 100% with the specifications.
- **ADVANCED OPTICAL MEASURING SYSTEM:**
- The slide carrier of the VS series scales, use a five bearing design for optical grating linear transducer which has been proven as the most reliable system design in today's market.
- The glass grating slide-ways are lapped, and JIS standard P5 grade bearings are used to achieve smooth and accurate movement and long working life.
- **D.I.Y. INSTALLATION:**
- An easy-to-follow D.I.Y. Installation Manual is supplied with each system, complete with illustrations and mounting brackets.

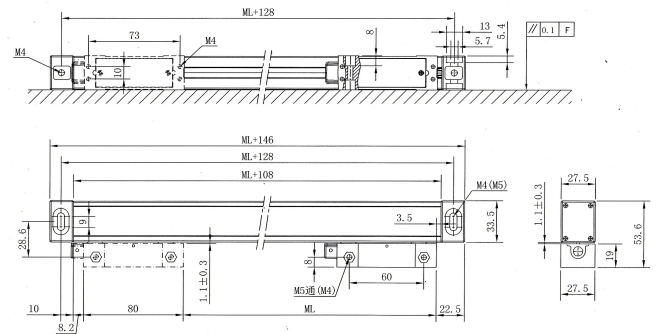

MODEL	VS 10	
Measuring Standard	Glass scale - Grating	
Optical Detecting System	Transmissive Infrared	
Slide Carrier System	Vertical five bearing supporting system	45° support
Resolution	5µm	
Measurement Travel (100-1200mm)	Every 50mm per length specification	
Measurement Travel (1300-3000mm)	-	Every length
Accuracy (100-450mm) Accuracy (500-1000mm) Accuracy (1050-1250mm) Accuracy (1300-3000mm)	±3 - ±5µm ±10µm ±10µm -	
Repeatability	2µm	
Hysteresis	3µm	
Protection	DIN	
Power Supply	DC	
Output Signals		

Product Brochure For D721

Specific Features



DSub9 Male Plug

Dsub 9
9 pin male connector plug

Pin	TTL Signal	Cable	422A Signal	Color
1	—	—	A	Yellow
2	0V	Orange	0V	White
3	—	—	B	Red
4	Gnd	Ground	Gnd	Ground
5	—	—	R	Black
6	A	Yellow	A	Green
7	5V	Red	5V	Brown
8	B	Green	B	Blue
9	R	Brown	R	Gray

Dsub9 Wiring Diagram



DIY INSTALLATION
An easy-to-follow DIY Installation Manual is supplied with each system, complete with illustrations and mounting brackets.

DIY Installation

Recommended Accessories

D709
Easson Scales - Extension Cable



D710
Easson Scales - Extension Cable



D772
Digital Readout Scale Mounting Bracket Kit



D711
Adaptor Cable



D712
Adaptor Cable

