

Product Brochure For E112

## 3HP Electric Motor - EM3-28

2800rpm, Ø19mm Shaft



**On Sale**

Ex GST	Inc GST
<del>\$320.00</del>	<del>\$352.00</del>
<b>\$299.09</b>	<b>\$329.00</b>

ORDER CODE:	E112
MODEL:	EM3-28
Motor Power (kW / hp):	2.25 / 3
Speed (rpm):	2800
Shaft Diameter (mm):	Ø19
Reversible Motor (Yes / No):	Yes
Fan Cooled (Yes / No):	Yes
Voltage (V):	240
Amps Required:	15
Input Power Supply Connection:	Includes Plug & Lead



### Description

Ideal for Compressors and Wood Working Machinery, and is well suited to most general applications.

### Features

- 240V motor
- TEFC - (Totally enclosed fan cooled)
- Reversible motor shaft direction
- Thermal overload with manual reset
- Foot mounted

Product Brochure For E112

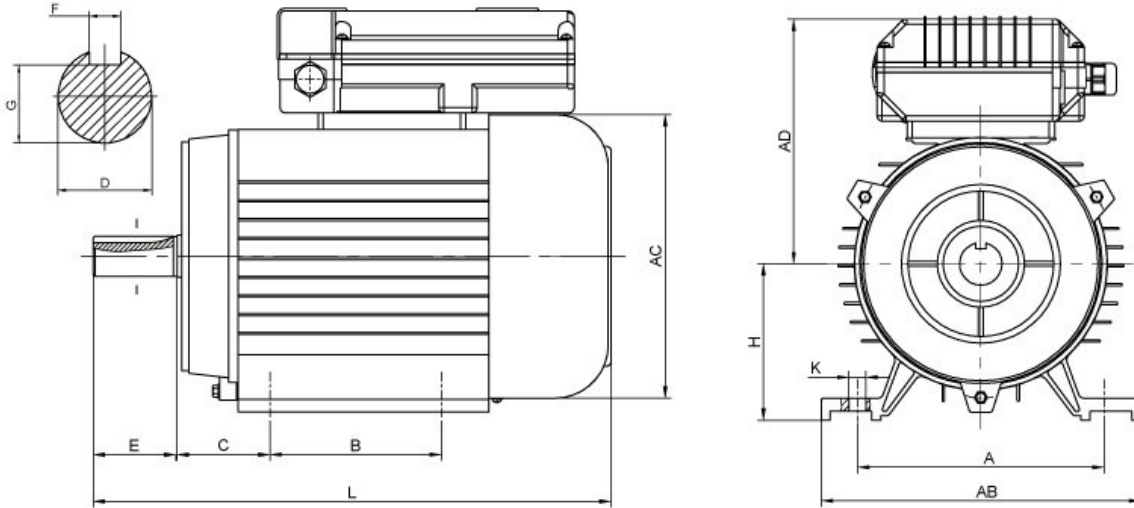

Model	Mounting Dimensions (mm)									Overall Dimensions (mm)			
	A	B	C	D	E	F	G	H	K	AB	AC	AD	L
EM1-14	125	100	50	15.9	40	4.8	13	80	10	155	156	160	295
EM25-28	140	100	56	19	50	6	16	90	10	168	174	155	320
EM2-14	140	125	56	19	50	6	16	90	10	168	174	155	345
EM3-28	140	125	56	19	50	6	16	90	10	168	174	155	345

Specific Features



Shown with Lead

SINGLE PHASE INDUCTION MOTOR				CE
FRAME	MEC90	POWER	3HP	
VOLTS	240V/50HZ	AMPS	14	
R.P.M.	2800	INS.CL.S.	B	
RATING COMP.	45uF/450V	150uF/350V		
IP54	MANUAL RESET OVERLOAD			
DATE	2011-06			

Specifications