

Product Brochure For K148

Opti-Turn Lathe & Mill Drill Combination Package Deal - TU-3008G-16M

300 x 700mm

Included BF-16AV Mill Head



OPTIMUM



ORDER CODE:	K148
MODEL:	TU-3008G-16M
KIT Includes:	TU-3008G & BF-16AV
Lathe Specifications:	LATHE SPECIFICATIONS
Tool Height To Suit (mm):	16
Distance Between Centres (mm):	700
Swing Over Bed (mm):	300
Swing Over Cross Slide (mm):	190
Centre Height (mm):	150
Spindle Bore (mm):	38
Spindle Nose Type:	D1-4
Bed Width (mm):	180
Headstock Taper (MT):	5
Tailstock Taper (MT):	3
Cross Slide Travel (mm):	150
Compound Slide Travel (mm):	65
Leadscrew:	Metric
Longitudinal Feed (Z-Axis) (mm/rev):	0.085 - 0.83
Cross Feed (X-Axis):	0.01 ~0.10
Metric Thread Range (mm):	0.2 - 3.5
Imperial Thread Range (TPI):	8 - 56"
Three Jaw Chuck Size (mm):	160
Four Jaw Chuck Size:	Optional
Spindle Speeds (No. / rpm):	12 (125 - 2400)
Motor Power - Lathe (kW / hp):	1.5 / 2
Voltage / Amperage - Lathe (V / amp):	240 / 10
Mill Specifications:	MILL SPECIFICATIONS
Spindle Taper (MT):	3
Column Type:	Dovetail
Swivel Head (Left ~ Right) (± Deg):	±90
Vertical Travel (Z-Axis) (mm):	210
Drilling Capacity (mm):	16
End Milling Capacity (mm):	20
Face Milling Capacity (mm):	63
Spindle Speeds Vertical (No. / rpm):	Variable (100-3000)
Motor Power - Mill (kW / hp):	0.5 / 0.66
Voltage / Amperage - Mill (V / amp):	240 / 10
Nett Weight (kg):	347

Description

TU-3008G-16M Combination Lathe & Mill-Drill consist of TU-3008G bench lathe & BF-16AV mill head

This new TU-3008G model geared head lathe of very modern design has many convenient facilities ideal for the enthusiastic model engineer for small component manufacturer. A very rigid 180mm cast iron bed width, induction hardened and ground slideways gives a high level of precision turning. The lathe capacity is 700mm between the centres and 300mm swing over the bed and with a generous 38mm spindle bore allowing larger stock to be placed through the headstock. The workhorse that drives this lathe has an upgraded powerful 2hp (1.5kW) motor providing smooth running.

Other very useful features included are cross and longitudinal power feeds that's not normally found of small conventional lathes, quick lock tailstock and both metric and imperial thread cutting, ranging from 8-56 tpi or 0.2-3.5mm pitch. Also included are a 4-way indexing tool post with 16mm tool shank capacity, fine adjustment on the tailstock for taper turning and the rear splash guard. A 160mm 3-jaw chuck with reverse jaws is also supplied.

Features

- LATHE: TU-3008G
- Geared headstock for quick change of 12 spindle speeds 125-2400rpm
- Ribbed prism bed made of grey cast iron
Inductively hardened and ground bed guideways

Product Brochure For K148

- Automatic cross & longitudinal power feeds
 - Spindle nose accuracy 0.009mm
 - 3 Jaw chuck running accuracy 0.04mm
 - D1-4 camlock spindle for quick chuck changes
 - Forward & reverse spindle direction switch
 - Oils sight glass on head-stock & gearbox
 - Change gears for metric and imperial thread cutting
 - Enclosed feed and threading gearbox
 - Belt cover with tamper proof safety micro switch
 - Heavy duty rotating safety chuck guard with micro switch
 - Sliding tool post safety guard
 - Cross slide and bed length designed to adapt Optimum DRO scales
-
- MILL: BF-16AV
 - Electronic infinitely variable speed (100-3000rpm)
 - Tilting head to $\pm 90^\circ$ from vertical
 - 3MT spindle taper
 - Adjustable dovetail slideway on Z-Axis
 - Heavy duty cast iron body and base for better stability
 - 2-speed gearbox (high/low) drive system to maximise torque
 - IP54 with low-voltage release switch
 - Scale collars for all axis are adjustable
 - Adjustable drill length stop
 - Metric dial graduations
- Note: The lathe rear splash tray is required to be removed to fit Mill Head Attachment.

Includes

- LATHE: TU-3008G
 - 160mm 3 jaw chuck with reverse jaws
 - Change gears for metric & Imperial thread cutting
 - Chuck guard
 - Toolpost guard
 - 2 dead centres
 - 3-jaw chuck with reversible jaws
 - Swarf drip tray
 - Rear splash guard
-
- MILL: BF-16AV
 - 3MT x JT6 drill chuck arbor
 - Safety cutter guard
 - Bracket kit for optional digital readout.

Specific Features



Front View



Left View



Right View Mill Table Ready



Front View Mill Table Setup

Product Brochure For K148



Left View Mill Table Ready



Mill Head Tilted to 45 Degrees



Close Up



Rear View



Mill Head Rear View

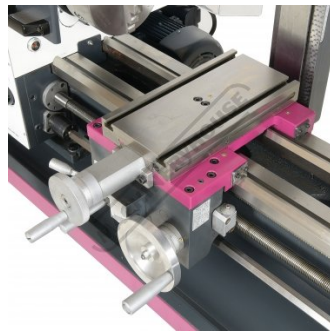

Mill Table



Shown with Optional Stand



Stand Sold Separately
Lathe



Top View



Front View



Shown with Optional Stand L690 Top View



Shown with Optional Stand L690 Left View



Safety Chuck Guard



Safety Chuck Guard Open Position



Headstock Controls



Spindle Speed Levers and Speed Chart

Product Brochure For K148



Headstock Controls



Top View Saddle and Chuck



Spindle Direction and Emergency Stop Switches



On Off Switch



Through Spindle

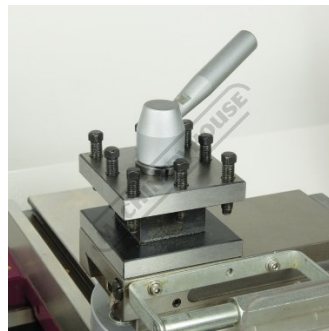

4 Way Toolpost

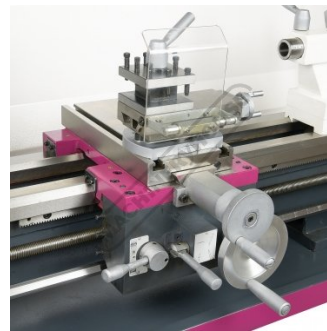

Saddle Left View



Saddle Front View

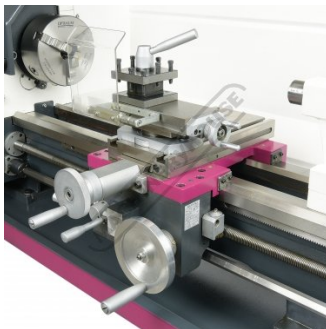

Saddle Right View

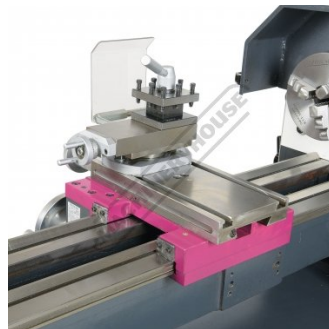

Saddle Rear View

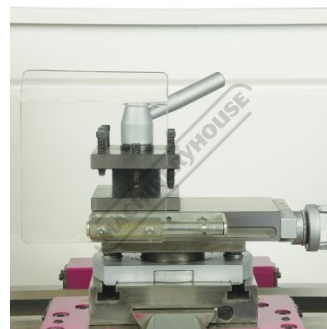

Safety Cutter Guard Left

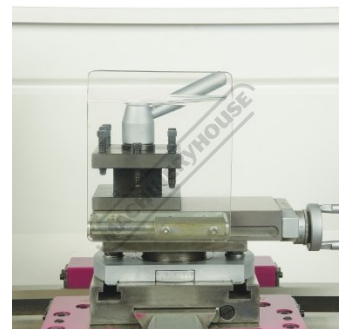

Safety Cutter Guard Right

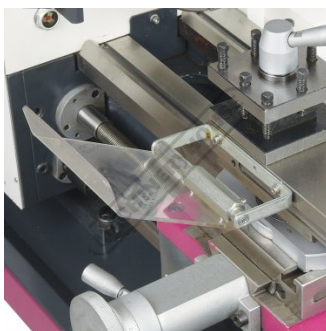

Safety Cutter Guard Tilted Down



Feed and Thread Engagement Levers

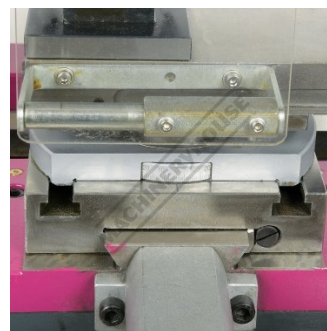

Swivel Compound Slide



Thread Chasing Dial

Product Brochure For K148

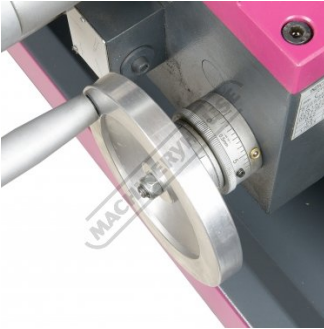

Saddle Handwheel Graduations

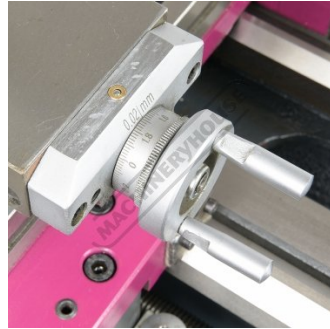

Compound Slide Hand Wheel



Cross Feed Hand Wheel Graduations



Tailstock



Tailstock Quill Graduations



Tailstock Horizontal Adjustment

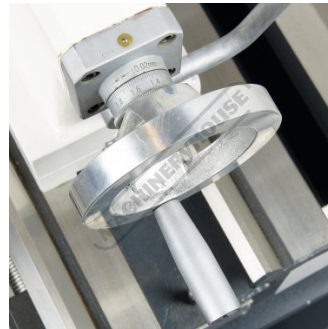

Tailstock Hand Wheel



Ground and Hardened Bed



Slides Ready For Mounting of DRO Scales



Mounting Point for Optional Milling Head

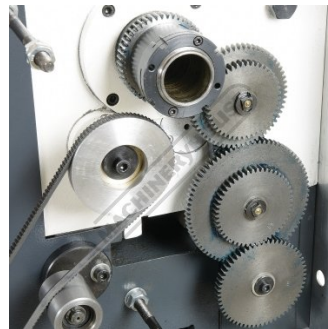

Change Gears



Parts Included



Mill Head



Control Panel



Safety Guard



Quill Handle

Product Brochure For K148



High Low Handle



Head Height Scale



Head Height Adjustment Handle



Quill Lock



Head Tilt Adjustment



Drawbar



Dovetail Column

Recommended Accessories

L690
 Lathe Stand



C252
 4 Jaw Independent Lathe Chuck



L6917
 Lathe Steady - Travelling



L6916
 Lathe Steady - Fixed



Product Brochure For K148

D695
 3-Axis Optimum Digital Readout Counter - 1µm



D694
 1500mm Optimum Magnetic Digital Readout Scale



P235
 Coolant Pump & Tank



L017
 Right Hand Turning Tool Holder



L018
 Left Hand Turning Tool Holder



L0077
 Lathe Turning Tool Kit - 7 piece Insert Type



L451
 Lathe Turning Tool Kit - 3 piece Insert Type



L457
 Lathe Threading Tool Kit - Insert Type



L465
 Professional Lathe Parting Tool Kit - Insert Type



C052
 3MT Live Centre



C290
 Heavy Duty Drill Chuck - Keyed Type



D443A
 3MT x JT3 Drill Chuck Arbor Kit



Product Brochure For K148

D1272

Metric 135° Precision HSS Drill Set - 25 Piece



D1282

Imperial 135° Precision HSS Drill Set - 29 Piece



D126

Metric 135° Precision HSS Drill Set - 170 Pieces



S090A

Soluble Metal Cutting Fluid - 1 Litre



S090

Soluble Metal Cutting Fluid - 5 Litre



S076

Cutting Tool Lubricant Fluid - 500ml



S077

Drilling, Tapping & Cutting Tool Lubricant Spray - 400g



S075

Cutting Tool Lubricant Paste - 200g



S074

Cutting Tool Lubricant Paste - 500g

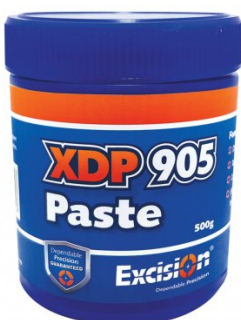

L341

Fitting and Machining Technical Book

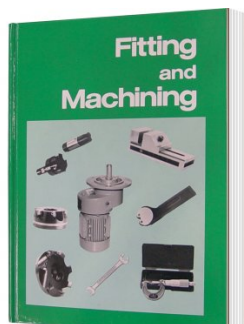

L3455

Professional Sheet Metal Fabrication Book

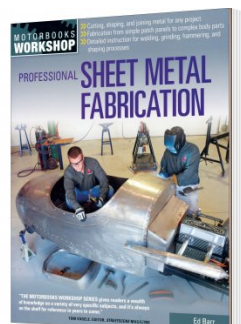

L300

Magnetic Swarf Remover



Product Brochure For K148

M9991
Magnetic Floor Sweeper



M800
Rubber Mat - Anti-Fatigue



M805
Rubber Mat - Anti-Fatigue

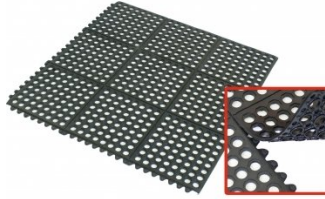

O000
SpillFix Universal Organic Absorbent



O043
Rust & Corrosion Preventive



O042
General Purpose Lubricant & Corrosion Inhibitor



O040
Rust & Corrosion Preventive



O044
Rust & Corrosion Preventive



C926
Collet & Chuck Set - 20 Piece



C922B
Collet & Chuck Set - 8 Piece



C090
Clamp Kit 58 piece - Workshop Series



C0948
Mini Clamp Kit 10 piece - Workshop Series



Product Brochure For K148

M3301
 Metric HSS Slot Drill & End Mill
 Set - 10 Piece



M3321
 Imperial HSS Slot Drill & End
 Mill Set - 10 Piece



M3280
 13mm HSS End Mill Long
 Series



M182
 Precision Boring Head Kit



M192
 Boring Head Shank



M180
 Boring Bar Set - 9 piece



M250
 Parallel Set - 8 Piece



M530
 Universal Milling Kit - 4 Piece



M528
 Face Mill 90° - Positive Rake



L066
 KYOCERA Carbide Inserts -
 Milling



V004
 Cast Iron Vee Block

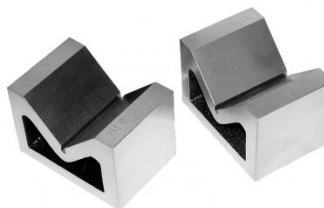

R001
 Rotary Table



Product Brochure For K148

R0014
Tilting Rotary Table

