

Product Brochure For L691

Opti-Turn Bench Lathe - TU-3008G

Ø300 x 700mm Turning Capacity - Ø38mm Spindle Bore
 12 Geared Head Speeds 125 ~ 2400rpm



Stand Sold Separately

OPTIMUM



On Sale

Ex GST	Inc GST
\$3,750.00	\$4,125.00
\$3,490.00	\$3,839.00

ORDER CODE:	L691
MODEL:	TU-3008G
Swing Over Bed (mm):	300
Distance Between Centres (mm):	700
Spindle Bore (mm):	38
Swing In Gap (mm):	~
Swing Over Cross-slide (mm):	190
Digital Readout System Fitted:	Optional
Quick Change Toolpost Fitted:	Optional
Leadscrew Covers Fitted:	~
Taper Turning Attachment:	~
Coolant System:	~
Tool Height To Suit (mm):	12
Centre Height (mm):	150
Spindle Nose Size or Type:	D1-4
Bed Width (mm):	180
Headstock Spindle Taper (MT):	5
Tailstock Taper (MT):	3
Cross Slide Travel (mm):	150
Compound Slide Travel (mm):	65
Leadscrew Type:	Metric
Metric Cross Feed (X-Axis) (mm/rev):	0.01 ~0.10
Imperial Cross Feed (X-Axis) (inch/rev):	~
Metric Longitudinal Feed (Z-Axis) (mm/rev):	0.085 - 0.83
Imperial Longitudinal Feed (Z-Axis) (inch/rev):	~
Metric Thread Steps & Pitch (No. / mm):	18 (0.2 - 3.5)
Imperial Thread Steps & TPI (No. / TPI):	21 (8 - 56")
3 Jaw Chuck Diameter (mm):	160
4 Jaw Chuck Diameter (mm):	Optional
Spindle Steps / Speeds (No. / rpm):	12 (125 - 2400)
Motor Power (kW / hp):	1.5 / 2
Voltage / Amperage (V / amp):	240 / 10
Nett Weight (kg):	280

Description

This new TU-3008G model geared head lathe of very modern design has many convenient facilities ideal for the enthusiastic model engineer for small component manufacturer. A very rigid 180mm cast iron bed width, induction hardened and ground slideways gives a high level of precision turning. The lathe capacity is 700mm between the centres and 300mm swing over the bed and with a generous 38mm spindle bore allowing larger stock to be placed through the headstock. The workhorse that drives this lathe has an upgraded powerful 2hp (1.5kW) motor providing smooth running.

Other very useful features included are cross and longitudinal power feeds that's not normally found of small conventional lathes, quick lock tailstock and both metric and imperial thread cutting, ranging from 8-56 tpi or 0.2-3.5mm pitch. Also included are a 4-way indexing tool post with 12mm tool shank capacity, fine adjustment on the tailstock for taper turning and the rear splash guard. A 160mm 3-jaw chuck with reverse jaws is also supplied. There are many additional options available including a milling head (BF-16AV) or (BF-20AV) to turn this machine into a very capable all round machining centre.

Features

- Geared headstock for quick change of 12 spindle speeds 125-2400rpm
- Ribbed prism bed made of grey cast iron
- Inductively hardened and ground bed guideways

Product Brochure For L691

- Automatic cross & longitudinal power feeds
- Spindle nose accuracy 0.009mm
- 3 Jaw chuck running accuracy 0.04mm
- D1-4 camlock spindle for quick chuck changes
- Forward & reverse spindle direction switch
- Oils sight glass on head-stock & gearbox
- Change gears for metric and imperial thread cutting
- Enclosed feed and threading gearbox
- Belt cover with tamper proof safety micro switch
- Heavy duty rotating safety chuck guard with micro switch
- Sliding tool post safety guard
- Cross slide & bed length are designed to fit Optimum DRO scales

Includes

- Change gears for metric & Imperial thread cutting
- Chuck guard
- Toolpost guard
- 2 dead centres
- 3-jaw chuck with reversible jaws
- Swarf drip tray
- Rear splash guard

Optional Accessories

- Stand with cabinet and drawers - L690
- 200mm 4 jaw independent chuck - C252
- Travelling steady - L6917
- Fixed steady - L6916

Specific Features



Right Front View



Front View



Shown with Optional Stand L690 Top View



Shown with Optional Stand L690 Left View



Safety Chuck Guard



Safety Chuck Guard Open Position



Headstock Controls



Spindle Speed Levers and Speed Chart

Product Brochure For L691



Headstock Controls

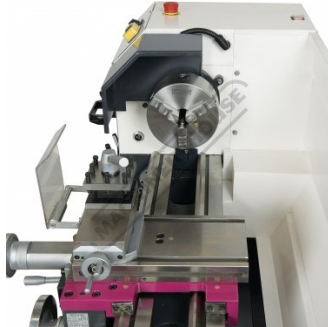

Top View Saddle and Chuck



Spindle Direction and Emergency Stop Switches



On Off Switch



38mm Through Spindle Bore

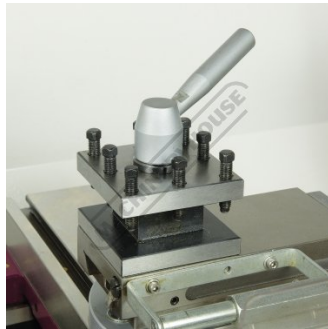

4 Way Toolpost

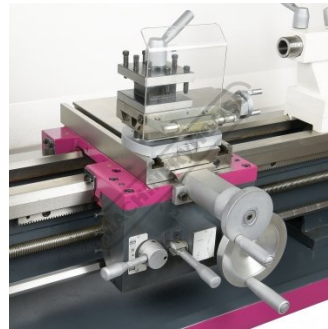

Saddle Left View

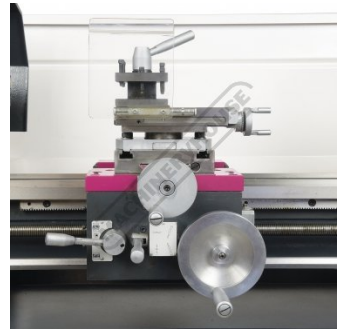

Saddle Front View

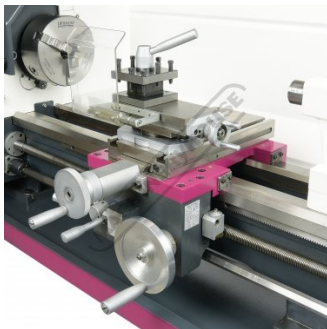

Saddle Right View

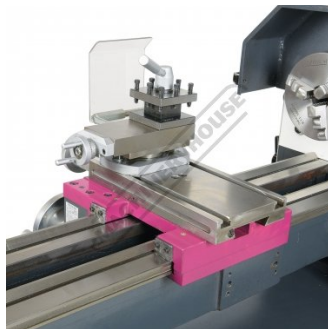

Saddle Rear View

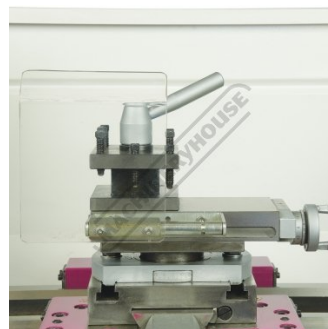

Safety Cutter Guard Left

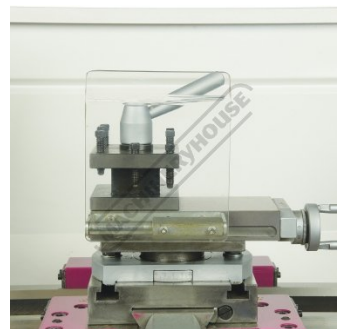

Safety Cutter Guard Right

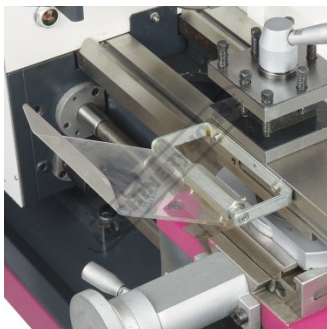

Safety Cutter Guard Tilted Down

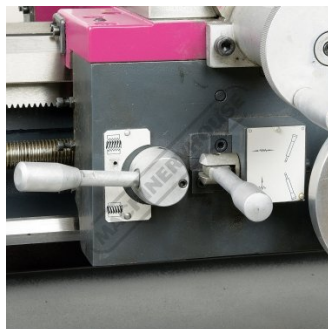

Feed and Thread Engagement Levers

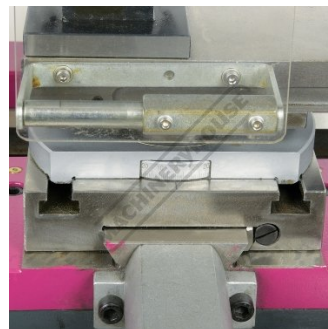

Swivel Compound Slide

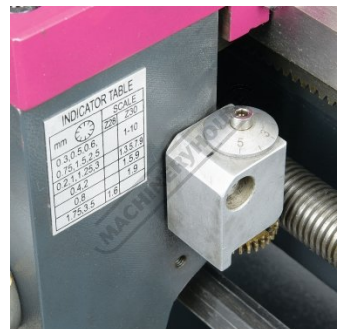

Thread Chasing Dial

Product Brochure For L691

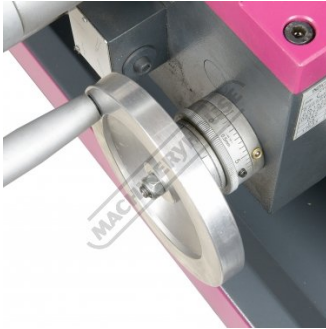

Saddle Handwheel Graduations



Compound Slide Hand Wheel



Cross Feed Hand Wheel Graduations



Tailstock

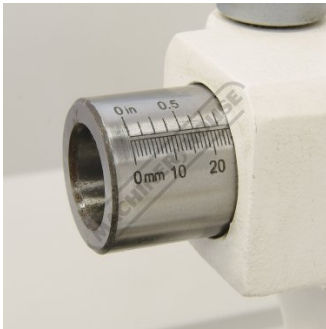

Tailstock Quill Graduations



Tailstock Horizontal Adjustment

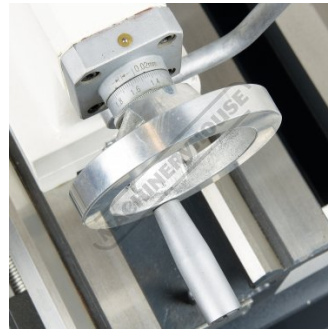

Tailstock Hand Wheel



Ground and Hardened Bed

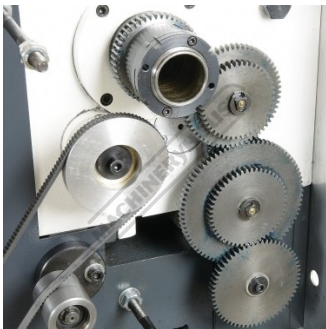

Change Gears



Slides Ready For Mounting of DRO Scales

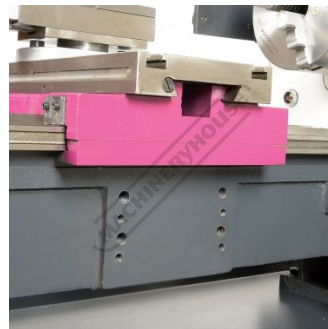

Mounting Point for Optional Milling Head



Parts Included

Product Brochure For L691

Recommended Accessories

K0012

Opti-Turn Bench Lathe Package Deal



K149

Opti-Turn Lathe & Mill Drill Combination Package Deal



L690

Lathe Stand



C252

4 Jaw Independent Lathe Chuck



L292

Quick Change Toolpost



L6917

Lathe Steady - Travelling



L6916

Lathe Steady - Fixed



M647

Opti-Mill Head Attachment - Geared & Tilting Head



Product Brochure For L691

D695
 3-Axis Optimum Digital Readout Counter - 1µm



D694
 1500mm Optimum Magnetic Digital Readout Scale



D697
 Optimum Magnetic Digital Readout Reader Head



P235
 Coolant Pump & Tank



L015
 Right Hand Turning Tool Holder



L016
 Left Hand Turning Tool Holder



L0099
 Lathe Turning Tool Kit - 7 piece Insert Type



L450
 Lathe Turning Tool Kit - 3 piece Insert Type



L456
 Lathe Threading Tool Kit - Insert Type



L464
 Professional Lathe Parting Tool Kit - Insert Type



C052
 3MT Live Centre



C290
 Heavy Duty Drill Chuck - Keyed Type



Product Brochure For L691

D443A
3MT x JT3 Drill Chuck Arbor



D1272
Metric 135° Precision HSS Drill Set - 25 Piece



D1282
Imperial 135° Precision HSS Drill Set - 29 Piece



D126
Metric 135° Precision HSS Drill Set - 170 Pieces



S090A
Soluble Metal Cutting Fluid - 1 Litre



S090
Soluble Metal Cutting Fluid - 5 Litre



S076
Cutting Tool Lubricant Fluid - 500ml



S077
Drilling, Tapping & Cutting Tool Lubricant Spray - 400g



S075
Cutting Tool Lubricant Paste - 200g



S074
Cutting Tool Lubricant Paste - 500g



L341
Fitting and Machining Technical Book

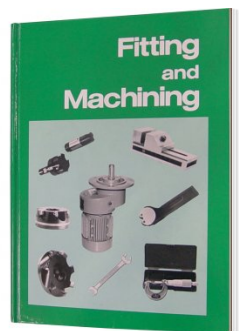

L3455
Professional Sheet Metal Fabrication Book

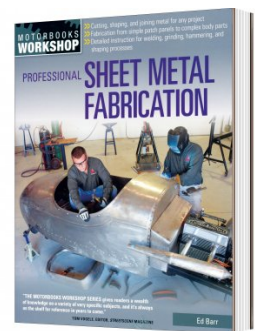

Product Brochure For L691

L300
 Magnetic Swarf Remover



M9991
 Magnetic Floor Sweeper



M800
 Rubber Mat - Anti-Fatigue



M805
 Rubber Mat - Anti-Fatigue

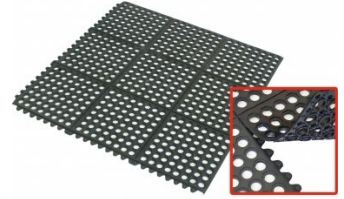

O000
 SpillFix Universal Organic Absorbent



O043
 Rust & Corrosion Preventive



O042
 General Purpose Lubricant & Corrosion Inhibitor



O040
 Rust & Corrosion Preventive



O044
 Rust & Corrosion Preventive

