

Product Brochure For L761

Lathe - Boring Ring for Chuck Soft Jaws

Ø8" (Ø200mm)

Ex GST
\$290.00

Inc GST
\$319.00

ORDER CODE:	L761
Size (inch):	8"
A (mm):	12
B (mm):	218
C (mm):	115
D (mm):	15
E (mm):	36
F (mm):	9
G (mm):	18.5
Nett Weight (kg):	2.4

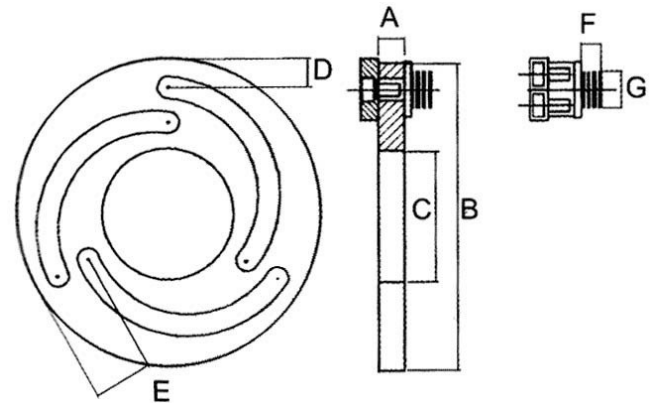

Description

To suit any lathe that uses soft jaws. The ring is used to hold the jaws in place so the the soft jaws can be machined to a certain size.

Material SCM440

Features

- Maintains a high level of accuracy
- The operation process is as follows
 1. Set the jaws to the correct position that will allow the diameter required to be machined.
 2. Adjust the boring ring so that the pins are located in the recessed hols in the jaws.
 3. Lock the chuck so that the boring ring is clamped.
 4. Machine the jaws to the required size.
 5. Unlock the chuck and remove the boring ring
 6. If the process is followed the jaws will repeat the accuracy each time the chuck is closed onto the work piece.