

Product Brochure For L78305

## Tube Fiber Laser Cutting - BODOR K2-92-6kW

9200mm Max Tube Length  
 Max Tube Weight 300Kg

### Please Call



ORDER CODE:	L78305
MODEL (Type):	K2-92 6kW
Laser Power (kW):	6
Cutting Length Capacity (mm):	9200
Max acceleration (G):	1
X/Y Axis Positioning accuracy (mm):	0.05
X/Y Axis Repeatability (mm):	0.03
Y Axis Maximum Speed (m/min):	60
X Axis Maximum Speed (m/min):	90
Z axis maximum speed (m/min):	50
Max Chuck Rotating Speed (r/min):	90
Max Load Capacity (kg):	300
Standard Tube Support Holder:	Yes
Laser Type:	Fiber Laser
Laser Source:	BodorPower
Laser Head:	BodorGenius T
Control System:	BodorThinker Tube
Round Tube (mm):	ø8-ø230
Square Tube (mm):	?8-?230
Rectangular Tube (mm):	~
Steel Angle (mm):	~
Steel Channel (mm):	~
Steel i Beam (mm):	~
Z-axis Active Obstacle Avoidance:	Yes
Auto Focus Laser Head:	Yes
Lightning Piercing:	Yes
Automatic tube inspection:	yes
Over edge protection:	Yes
Drawing File (type):	G Code, DXF, DWG
Chuck Drive Type:	Pneumatic Chuck
Waste Trolley:	Yes
Bevel Tube Cutting:	No
Slag cleaning module:	Optional
Machine Size (mm):	12359 x 1872 x 2286
Nett Weight (kg):	4000



### Description

K-Series is designed to handle the challenges of metal tube manufacturing, delivering precision, efficiency, and reliability with every use.

K-Series is the economical choice for precise tube processing with excellent performance with huge savings.

### Features

- Intelligent chuck -K series' pneumatic chucks are well-suited for stable performance in dynamic applications. Each of the two chucks is able to complete clamping in just 2 seconds with a strong chucking force. It also reduces scrap to only 45 mm, limiting waste and facilitating regular on-site maintenance.
- Cutting of different tubes and profiles - K series machines allow users to manufacture standard and customized-shaped steel tubes for their project needs. They have the capability to cut tubing in square, rectangular, flat oval, elliptical and many other custom shapes in a variety of metals.
- BodorThinker - BodorThinker is a high-end intelligent control system for a CNC laser cutter, featuring reliable stability, convenient installation and adjustment, safe production, multiple functionality, and robust performance. With BodorThinker, your laser cutting solutions can be modular, customized, automated and information-based.
- BodorNest Tube - BodorNest Tube is system designed for intelligent tube processing. It works with a diverse range of tube materials. Users can customize tube cutting layouts to fulfill different fabrication needs. This software increases material utilization rate by 15% and layout speed by 25%, facilitating the process of tube nesting. It also seamlessly integrates with other business software such as Tekla and Tribon.
- Edge collision prevention - When cutting rectangular or square tubes, the K series system calculates the tube's corner rotation radius through the function, effectively preventing collisions between the laser head and the tube, and thus avoiding any damage to the laser

Product Brochure For L78305

head.

**Includes**

- BodorGenius T: The specialized design of slender nozzle allows the machine to avoid interference and cut various types of tubes.
- Bodor Power: The backbone of any laser cutting system, and BodorPower takes it to the next level. This original laser source is the key to Bodor's high power processing (up to 60kW). It ensures longer lifespans, safer operations, and superior cutting results of every Bodor cutting machine.
- BodorThinker: Serves as the intelligent core of Bodor's laser cutting solutions. This control system integrates seamlessly with MES and ERP systems, facilitating automated production process management and information exchange through standardised communication protocols.
- 21.5 Inch Display
- Local Service and Support
- Oxygen & Nitrogen Regulators with hoses
- \*12 month warranty on machine parts & labor
- Commissioning & Testing Included (Metro Areas)
- Comprehensive Operator Training Included (Metro Areas)
- \*Five year factory warranty on - Bodor Thinker Control System, Bodor Power Laser Source, Bodor Genius Laser Head.

**Optional Accessories**

- MMF-4L - Laser Fume Extraction 5.5kW (W2723)
- K series automation devices like K-Loader and K-Trans optimises material flow and boosts output of production

**Cutting parameters Speed and Thickness**

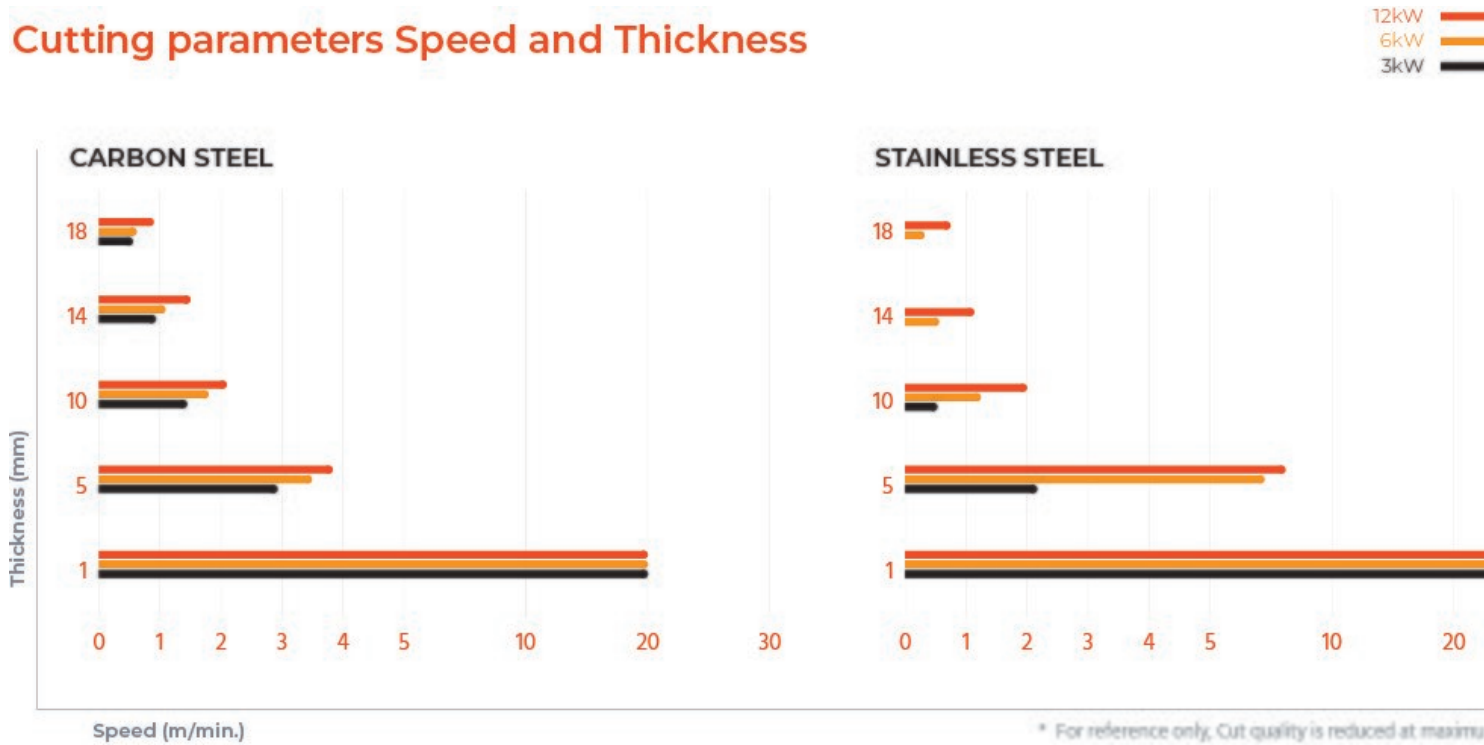

Product Brochure For L78305

**Specific Features**

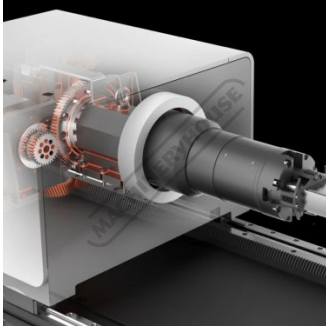

Intelligent Chuck



Tube Chuck



BodorNest Tube



Profile 1



Profile

**Recommended Accessories**

W2723

Laser Fume Extraction



C5051

Pilot Air Compressor

