

Product Brochure For M165

NT30-MT2-50 Milling Adaptor



On Sale

Ex GST	Inc GST
\$70.00	\$77.00
\$59.09	\$65.00

ORDER CODE:	M165
MODEL:	NT30-MT2-50
Outer Taper:	NT30
Inside Taper:	MT2
Drawbar Thread (mm / inch):	12mm
L (mm):	50
C (mm):	32
Nett Weight (kg):	0.80

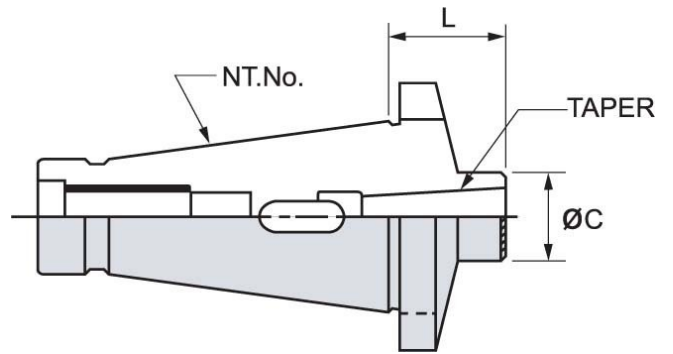

Description

Precision ground and hardened.
 Morse taper adaptors are used to adapt a Morse taper tool or cutter to any spindle taper