

Product Brochure For M169

R8-MT2-30 Milling Adaptor

On Sale

Ex GST	Inc GST
\$45.00	\$49.50
\$39.09	\$43.00

ORDER CODE:	M169
MODEL:	R8-MT2-30
Outer Taper:	R8
Inside Taper:	MT2
Drawbar Thread (mm / inch):	7/16"
L (mm):	30
C (mm):	32
Nett Weight (kg):	0.40

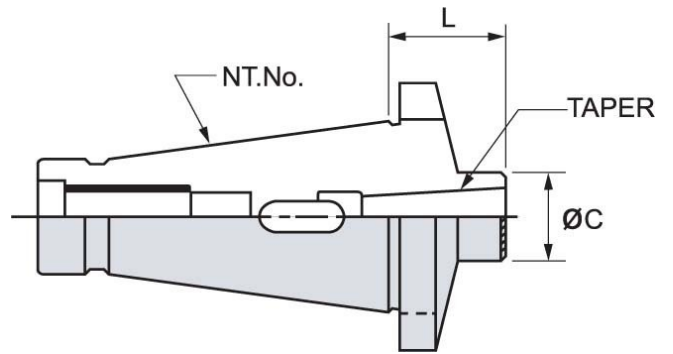

Description

Precision ground and hardened.
 Morse taper adaptors are used to adapt a Morse taper tool or cutter to any spindle taper