

Product Brochure For M172

NT40-MT4-93 Milling Adaptor

On Sale

Ex GST	Inc GST
\$95.00	\$104.50
\$80.91	\$89.00

ORDER CODE:	M172
MODEL:	NT40-MT4-93
Outer Taper:	NT40
Inside Taper:	MT4
Drawbar Thread (mm / inch):	16mm
L (mm):	93
C (mm):	48
Nett Weight (kg):	1.50

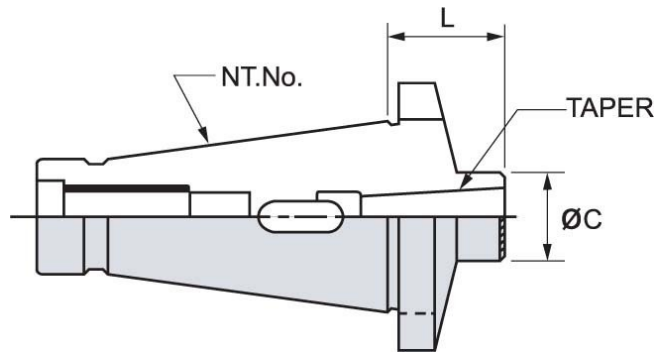

Description

Precision ground and hardened.
 Morse taper adaptors are used to adapt a Morse taper tool or cutter to any spindle taper