

Product Brochure For M554

Face Mill Arbor - NT40 - FMB32-20

On Sale

Ex GST	Inc GST
\$90.00	\$99.00
\$75.45	\$83.00



ORDER CODE:	M554
MODEL:	NT40 - FMB32-20
Draw Bar (mm / inch):	16mm
D (mm):	32
H (mm):	21
K (mm):	7
C (mm):	73
L (mm):	20
Nett Weight (kg):	2.40

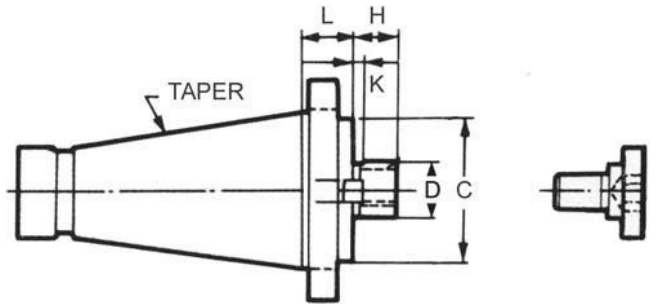

Features

- Material: SCM-21
- Hardness: HRC 50° - 55°
- Squareness of mounting surface: Less than 0.0002" (0.005mm)
- Deflection in shaft and taper: Less than 0.0002" (0.005mm)

Product Brochure For M554

Recommended Accessories

M513

Face Mill 90° - Positive Rake

M518

Face Mill 45° - Super High-Rake

