

Product Brochure For P6001

8 x 8mm Square Punch

Hi -Grade Tool Steel Imported From Japan
 Ø30mm Locating Diameter



Back In Stock Soon

Ex GST
\$100.00

Inc GST
\$110.00

ORDER CODE:	P6001
Shape - Type:	Square Punch - SP1
Square or Slot Hole Size (W x L) (mm):	8 x 8
Punch Locating Diameter x Length (mm):	Ø30 x 70mm
Die Outside Body Diameter x Height (mm):	~

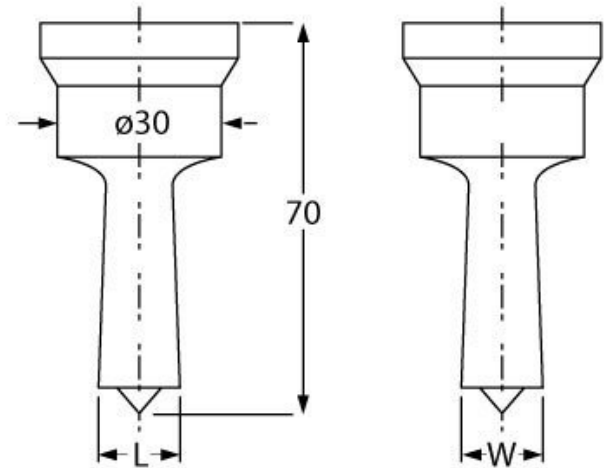

Description

Punch and Dies are Manufactured by Sunrise in Taiwan using Hi -Grade Tool Steel imported from Japan. The manufacturing process involves machining via hi tech CNC machines lathes & mills, vacuum heat treatment with multiple tempering at high temperatures before a final quality inspection/testing process all of which ensures an accurate, precise, durable & stable product.

Features

- PLEASE NOTE FOLLOWING RECOMMENDATIONS WHEN SELECTING DIE CLEARANCE:
- Material Thickness - 2 ~ 4mm = Die Clearance 0.2mm
- Material Thickness - 4 ~ 9.5mm = Die Clearance 0.7mm
- Material Thickness - 10 ~ 14.5mm = Die Clearance 1.2mm
- Material Thickness - 15 ~ 19.5mm = Die Clearance 1.7mm
- Material Thickness - 20 ~ 24mm = Die Clearance 2.2mm

Optional Accessories

- Please Note: Square punch requires a sleeve to fit on current Sunrise machines
- Models IW-45MQ, IW-45K, IW-60H requires (PP630A)
- Models IW-60S/SD, IW-80S/SD, IW-100S/SD, IW-125S/SD, IW-165S/SD requires (PP630)

Product Brochure For P6001

Specific Features



Top View

Recommended Accessories

P6002
 8.7 x 8.7mm Square Die



PP630A
 QUICK CHANGE ADAPTOR
 30MM



PP630
 QUICK CHANGE ADAPTOR
 30MM



PP705
 DIE REDUCING BUSH



PP0016
 DIE RING SPACER

