

Product Brochure For P732

**Ø32mm Round Punch - RPN2**

Hi-Grade Tool Steel Imported From Japan

**Ex GST**  
**\$70.00**

**Inc GST**  
**\$77.00**



ORDER CODE:	P732
MODEL:	RPN2
Type:	Punch
Punch Diameter (D) (mm):	Ø32
Die Diameter (D) (mm):	~
Pack Quantity (No.):	1



**Description**

Punch and Dies are Manufactured by Sunrise in Taiwan using Hi-Grade Tool Steel imported from Japan. The manufacturing process involves machining via hi tech CNC machines lathes & mills, vacuum heat treatment with multiple tempering at high temperatures before a final quality inspection/testing process all of which ensures an accurate, precise, durable & stable product.

**Features**

- PLEASE NOTE FOLLOWING RECOMMENDATIONS WHEN SELECTING DIE CLEARANCE:
- Material Thickness - 2 ~ 4mm = Die Clearance 0.2mm
- Material Thickness - 4 ~ 9.5mm = Die Clearance 0.7mm
- Material Thickness - 10 ~ 14.5mm = Die Clearance 1.2mm
- Material Thickness - 15 ~ 19.5mm = Die Clearance 1.7mm
- Material Thickness - 20 ~ 24mm = Die Clearance 2.2mm

**Optional Accessories**

- Other sizes and shapes available on request

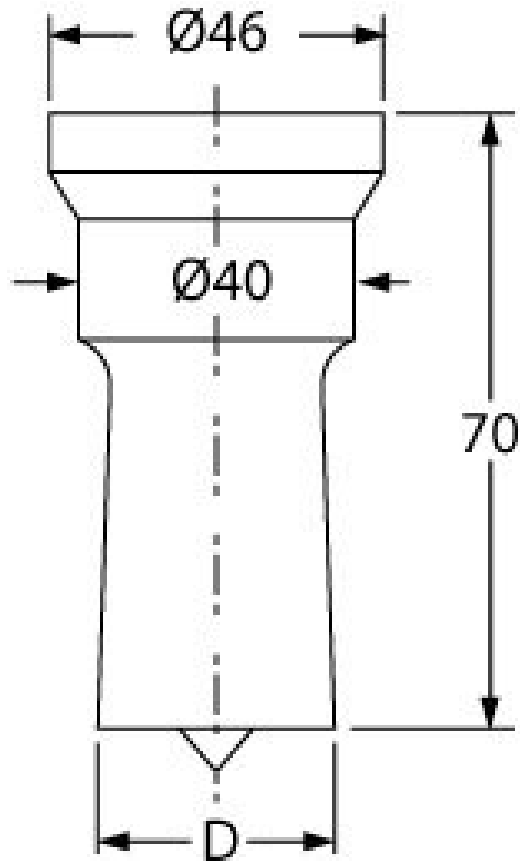

Product Brochure For P732

---

**Recommended Accessories**

P732B  
Ø32.2mm Round Die - RDN2



P732A  
Ø32.7mm Round Die - RDN2



P733B  
Ø33.2mm Round Die - RDN2



P733A  
Ø33.7mm Round Die - RDN2



P734B  
Ø34.2mm Round Die - RDN2



P734A  
Ø34.7mm Round Die - RDN2



P735B  
Ø35.2mm Round Die - RDN2

