

Product Brochure For P738

Ø38mm Round Punch - RPN2

Hi -Grade Tool Steel Imported From Japan

Back In Stock Soon

Ex GST

\$70.00

Inc GST

\$77.00



ORDER CODE:	P738
MODEL:	RPN2
Type:	Punch
Punch Diameter (D) (mm):	Ø38
Die Diameter (D) (mm):	~
Pack Quantity (No.):	1



Description

Punch and Dies are Manufactured by Sunrise in Taiwan using Hi -Grade Tool Steel imported from Japan. The manufacturing process involves machining via hi tech CNC machines lathes & mills, vacuum heat treatment with multiple tempering at high temperatures before a final quality inspection/testing process all of which ensures an accurate, precise, durable & stable product.

Features

- PLEASE NOTE FOLLOWING RECOMMENDATIONS WHEN SELECTING DIE CLEARANCE:
- Material Thickness - 2 ~ 4mm = Die Clearance 0.2mm
- Material Thickness - 4 ~ 9.5mm = Die Clearance 0.7mm
- Material Thickness - 10 ~ 14.5mm = Die Clearance 1.2mm
- Material Thickness - 15 ~ 19.5mm = Die Clearance 1.7mm
- Material Thickness - 20 ~ 24mm = Die Clearance 2.2mm

Optional Accessories

- Other sizes and shapes available on request

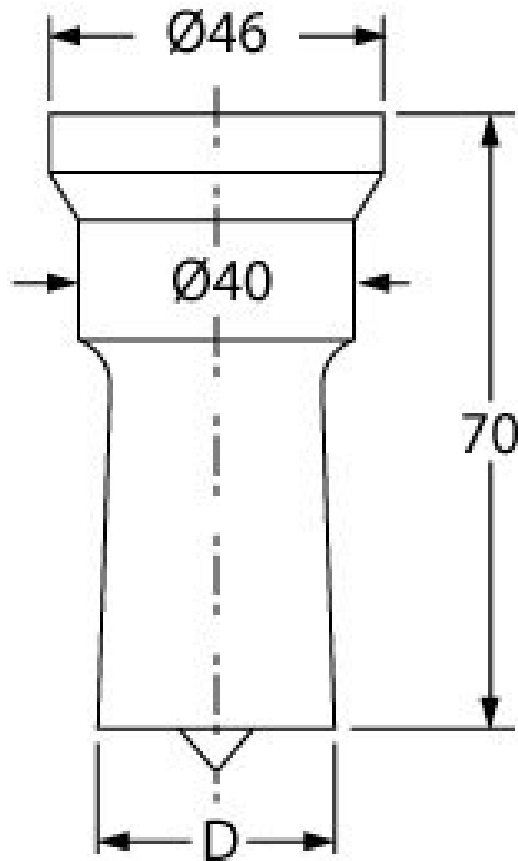

Product Brochure For P738

Recommended Accessories

P738B
Ø38.2mm Round Die - RDN2

P738A
Ø38.7mm Round Die - RDN2

P739B
Ø39.2mm Round Die - RDN2

P739A
Ø39.7mm Round Die - RDN2



P740B
Ø40.2mm Round Die - RDN2

P740A
Ø40.7mm Round Die - RDN2

P741B
Ø41.2mm Round Die - RDN3

