

Product Brochure For Q124

## Digital Outside Micrometer - 10-124

0-25mm / 0-1"



**On Sale**

<b>Ex GST</b>	<b>Inc GST</b>
<b>\$120.00</b>	<b>\$132.00</b>
<b>\$100.00</b>	<b>\$110.00</b>

ORDER CODE:	Q124
Range (mm / inch):	0 - 25mm / 0 - 1"
Accuracy (mm):	±0.002
C (mm):	23
L (mm):	32
Protection Rating:	~
Direct RS-232 output (Yes / No):	No

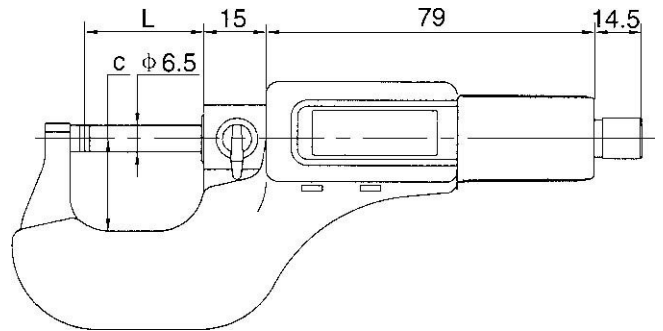

### Description

Quick, accurate and easy to use, at an economical price.

### Features

- Large LCD for easy reading
- Metric-imperial conversion and zero setting keys
- Friction thimble for easy one hand use
- Painted frame. Carbide measuring faces
- Resolution: 0.001mm/0.0005"

### Includes

- Includes CR2032 battery
- Ball point adaptor for use with round pipe or tubes (wall thickness)

## Product Brochure For Q124

---

### Specific Features



Shown with Ball Point Adaptor

### Recommended Accessories

Q675

Micrometer Stand

