

Product Brochure For Q134

Internal Micrometers - Caliper Jaw Type - 25-134

5-30mm

On Sale

Ex GST	Inc GST
\$150.00	\$165.00
\$126.36	\$139.00

ORDER CODE:	Q134
Range (mm):	5 - 30
Graduation (mm):	0.01
Accuracy (mm):	0.005

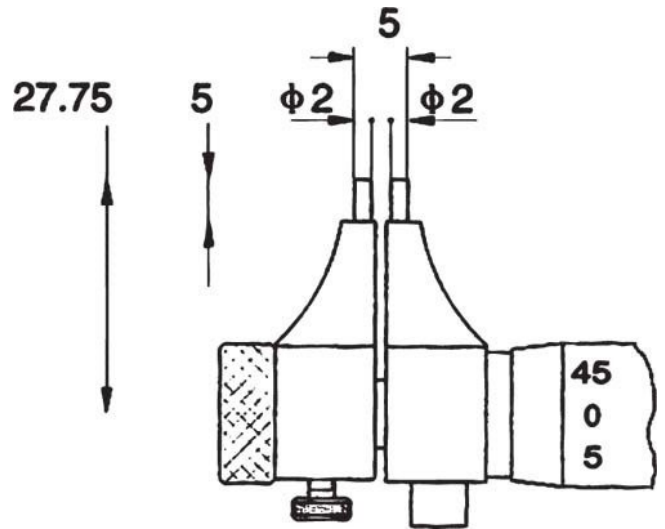

Description

Measumax caliper type micrometers allow internal measurements of small parts to be uniform and extremely accurate

Features

- Micro-fine graduations on satin chrome finish
- Carbide measuring faces
- Jaws made from high grade tool steel
- Standard setting ring supplied
- Graduation: 0.01mm
- Accuracy: 0.005mm

Product Brochure For Q134

Specific Features



Jaws Open



Setting Ring



Storage Case