

Product Brochure For Q234

Gear Tooth Vernier Caliper - 33-234

1-26 module

On Sale

Ex GST

Inc GST

~~\$160.00~~

~~\$176.00~~

\$135.45

\$149.00

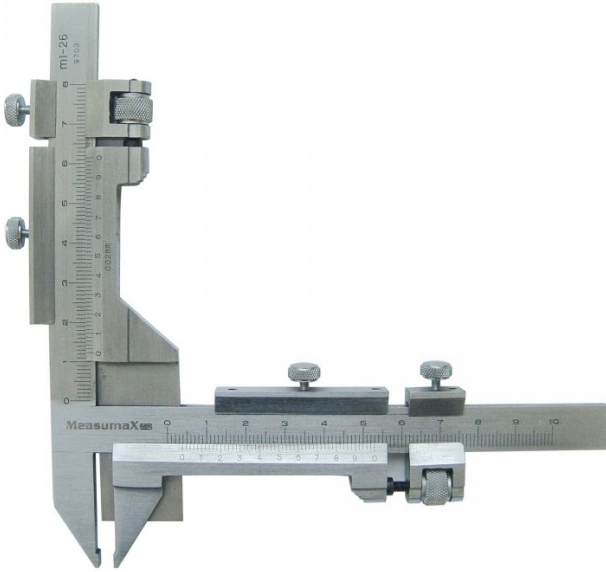

ORDER CODE:	Q234
Range:	1 - 26 Module
Graduations (mm):	0.02
Accuracy (mm):	±0.02



Features

- One of the benefits using a caliper is that the gear does not have to be removed from the machine
- The caliper consists of two adjustable verniers, that reference two dimensions on the gear and provide a measurement
- Vertical scale: Measures the depth of the teeth from the top of the pitch line
- Horizontal Scale: This is used to measure the Chordal Thickness of the gear tooth

Product Brochure For Q234

Specific Features



Shown measuring gear



Shown measuring gear