

Product Brochure For Q675

Micrometer Stand - 38-675

0-100mm

On Sale

Ex GST
~~\$35.00~~
\$29.09

Inc GST
~~\$38.50~~
\$32.00

ORDER CODE:	Q675
Type:	Micrometer Stand
Range (mm):	100
Nett Weight (kg):	1.2

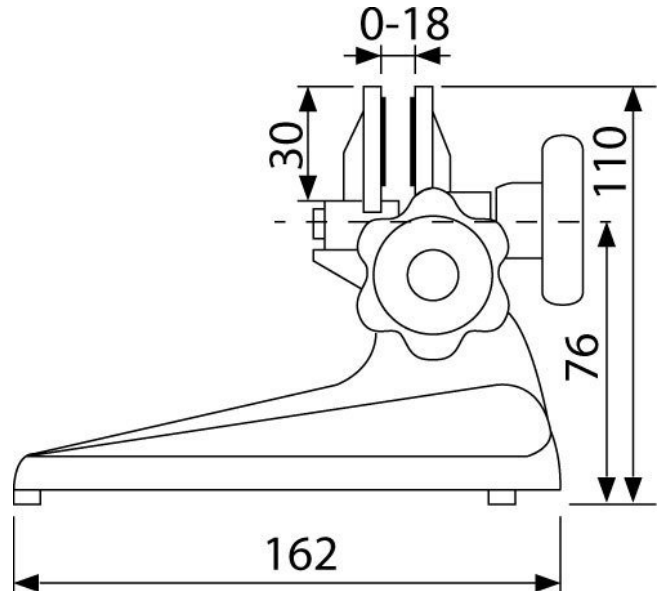

Features

- Micrometer stand to suit micrometers up to 100mm
- Cast iron construction for rigidity
- Clamps are made of die-casting aluminium
- Rubber pads on clamps to protect instruments
- Rubber foot pads to reduce slipping
- Ideal when checking multiple items and setting the micrometer

Product Brochure For Q675

Specific Features



Front Angle View



Rear View



Front View



Rubber Foot Pads



Shown with Optional Micrometer in Clamped Position



Shown with Optional Micrometer in Clamp Position