

Product Brochure For Q8536

920mm Digital Readout Scale - MX-300-920/5U

MX-300 Standard Scale
 5µm Resolution

On Sale

Ex GST	Inc GST
\$180.00	\$198.00
\$153.64	\$169.00



ORDER CODE:	Q8536
MODEL:	MX-300
Type:	Linear Scale
Travel - Maximum (mm):	920
Overall Length (L) (mm):	1026
Scale Resolution (µm):	5µm (0.005mm)
Grating Pitch:	20µm (0.02mm)
Accuracy (µm):	±0.005mm?±0.01mm/M
Output Signal:	5V TTL
Connector:	9 pin D-Sub
Cable Length (Metre):	3m metal conduit
Working Temperature (°C):	-10?—60?
Sealing Protection Class:	Class: IP54
Maximum Speed (M/min):	60M/Min
Reference Point:	Every 50mm
Width x Height (W x H) (mm):	~
Backing Support Plate (Yes / No):	Yes



Description

The Measumax MX-300 & MX-600 series linear scales are available in measuring lengths from 370 to 3000mm. With a 5µm resolution and a response speed of 60m/min these scales deliver 100% accuracy.

Features

- NSK Japanese, five bearing sliding structure for a smooth and accurate movement along the length of the scale
- Glass scale with 5µm resolution
- Scale body made from extruded Aluminium with wiper seals providing IP54 protection
- MX-300 series 15 x 34.5mm (W x H) section
- 3m connection cable with 9 pin D-Sub connector

Includes

- 920mm Linear scale
- Scale cover
- 1 x Angle 'B2' Bracket Slotted and Tapped (40x50x8mm x 80mm wide)
- 1 x Flat 'D2' Bracket Slotted and Tapped (70x80x10mm)
- Screws and washers

MeasumaX^{MX}
MX-300 Series - LINEAR SCALES

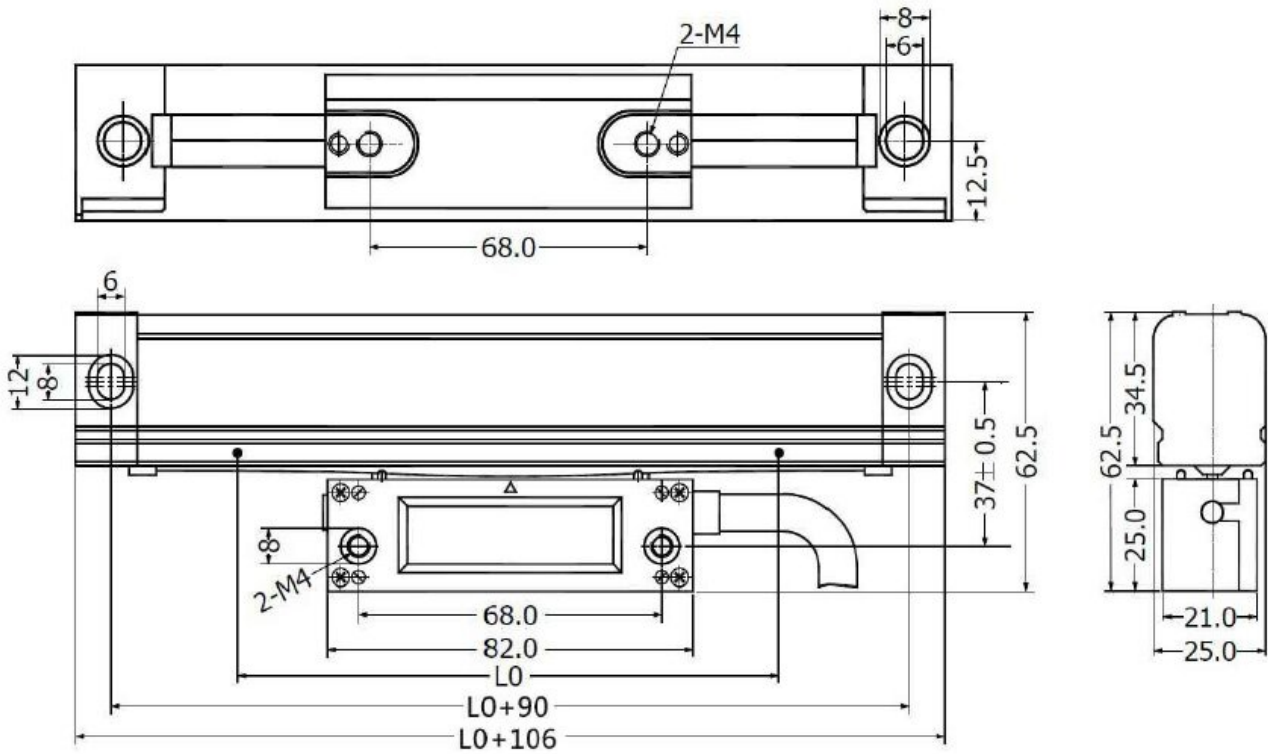

L0 = Effective measuring length of scale

Product Brochure For Q8536

Specific Features



Scale Covers

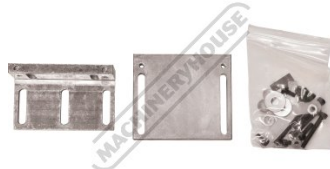

Mounting Bracket

Recommended Accessories

Q8500
 3-Axis Digital Readout

D709
 Easson Scales - Extension
 Cable

D710
 Easson Scales - Extension
 Cable

