

Product Brochure For R012B

Vertex Rotary Table - HV-16

Ø406mm



On Sale

Ex GST	Inc GST
\$2,090.00	\$2,299.00
\$1,950.00	\$2,145.00

ORDER CODE:	R012B
MODEL:	HV-16
Size (mm):	406
A1 (mm):	150
D (mm):	406
H (mm):	155
H1 (mm):	255
A (mm):	500
B (mm):	430
e (mm):	16
g (mm):	18
Number of T-Slots (No.):	6
T-Slot Size (mm):	16
Taper In Centre (MT):	4MT
Nett Weight (kg):	110



Description

Manufactured in Taiwan

The Vertex Rotary Table has been designed to be used where a precision work positioning device is required. It allows the operator to mill or drill components at exact intervals around a fixed axis. Additional indexing plates can be fitted to allow the Vertex Rotary Table to be used as a Dividing Head. The Vertex Rotary Table can be used in both the horizontal or vertical plane.

Features

- The Vertex Rotary Table is manufactured from high-density Meehanite cast iron with ground surface areas on the table and body to ensure smooth rotation
- Critical wear parts are hand finished for ultra precision
- All tables are tested for accuracy using 'Heidenhain' electronic equipment to ensure continuing quality
- Worm is hardened and precision ground, with a ratio of 90:1
- Table is graduated to a full 360° so one turn of the handle moves the table 4°
- The collar on the handle is graduated with a vernier scale, readings down to 10 seconds are possible

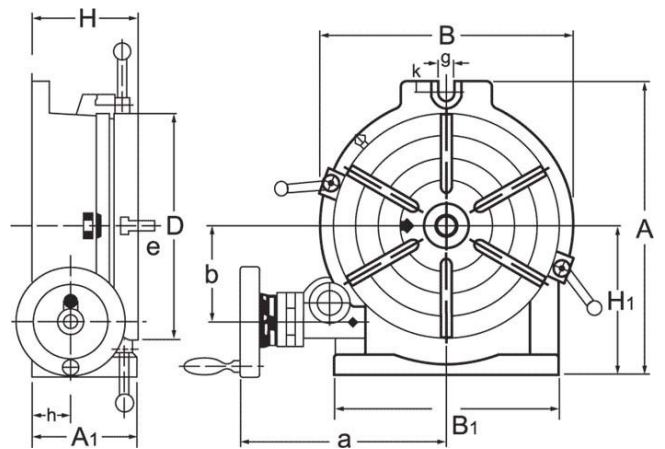

Product Brochure For R012B

Specific Features



Vertical View

Recommended Accessories

R020
Vertex Dividing Plate

C281
3 Jaw Self Centring Lathe
Chuck

C087
Clamp Kit Tee Nuts

C096A
Clamp Kit 58 piece - Industrial
Series

