

Product Brochure For S6333

Louvre Bead Roller Set - MBR-LST

6.5mm High x 14mm Width

Suits MBR-610 & MBR-1070 Bead Rollers



On Sale

Ex GST
~~\$100.00~~
\$90.00

Inc GST
~~\$110.00~~
\$99.00

ORDER CODE:	S6333
MODEL:	MBR-LST
Part Number:	~
Type:	Louvre Bead Roller Set
Size (inch / mm):	6.5mm High x 14mm Width
Roller Diameter (mm):	Ø75
Bore Diameter (mm):	Ø20 with Keyway
Spigot Diameter (mm):	~
Shaft Diameter:	~
Capacity (Mild Steel) (mm / Gauge):	1.2 / 18
Material (Type):	Steel
Suits:	MBR-610 & MBR-1070 & Bead Rollers

METALMASTER



Description

Roller set made from CR12 steel & Hardened up to 45 HRC

Includes

- 1 x 6.5mm High x 14mm Wide Louvre Roller Set

Product Brochure For S6333

Specific Features



Set



Side View



Top View



Rear View



Shown on Machine



Shown on Machine Side View

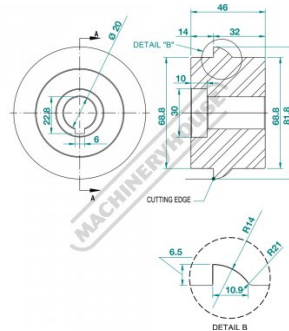

Dimensions 1

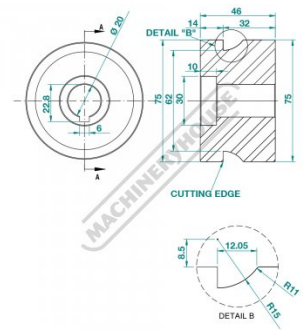

Dimensions 2

Recommended Accessories

S633

Bead Roller - Motorised Variable Speed



S634

Bead Roller - Motorised Variable Speed

