

Product Brochure For V1541

Heavy Duty - Drill Press Vice - TMV-100H

100mm Jaw Width
 110mm Jaw Opening

On Sale

Ex GST	Inc GST
\$140.00	\$154.00
\$117.27	\$129.00



ORDER CODE:	V1541
MODEL:	TMV-100H
Type:	Heavy Duty Drill Vice
Jaw Width (mm):	100
Jaw Opening (mm):	110
Jaw Depth (mm):	35
Nett Weight (kg):	8



Description

Heavy duty drill vice designed specifically for machine shop or tool room use. The bottom of the base is machined and slots are provided for securing to worktable.

Features

- Heavy-duty cast iron construction
- Precision ground prismatic jaws
- Precision ground base & bed for smooth lateral movement of the jaw
- Jaw guides to prevent tilting
- 100mm jaw width
- 110mm jaw opening
- 35mm jaw height

Product Brochure For V1541

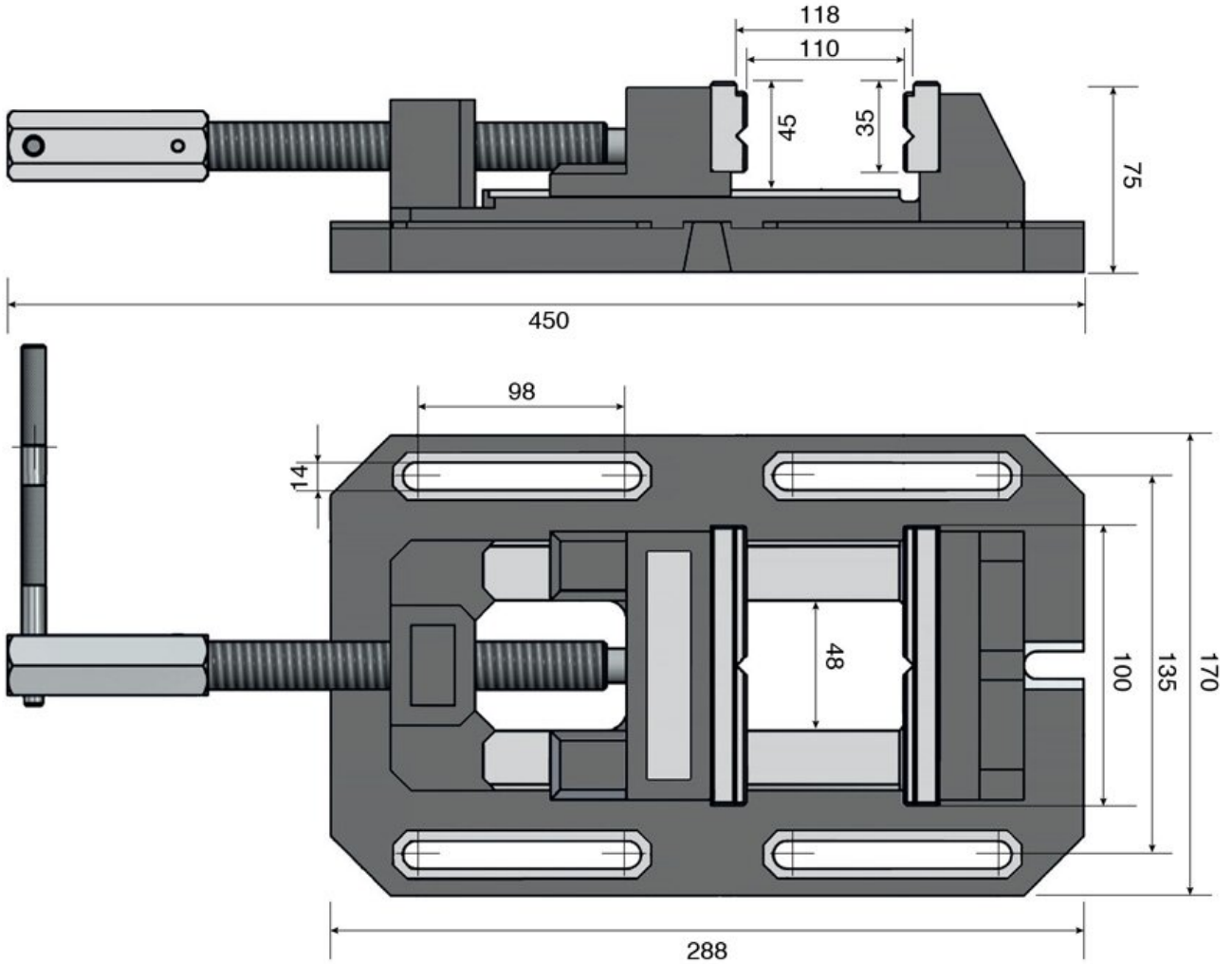

* Dimensions are provided solely for the purpose of the illustration: product tolerance may exhibit variations.

Product Brochure For V1541

Specific Features



Rear View

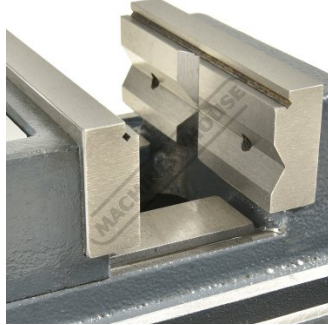

Jaws

Recommended Accessories

V053

Aluminium Magnetic Soft Jaws

V0537

Aluminium Magnetic Soft Jaws

V0534

Aluminium Magnetic Soft Jaws

V054

Plastic Magnetic Soft Jaws

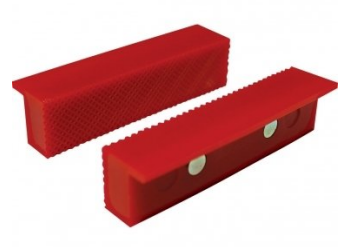

V0544

Plastic Magnetic Soft Jaws

