

Product Brochure For W30485

# 11mm - Square Carbide Insert

2 Piece Pack

**Coming Soon**

**Ex GST**  
**\$18.00**

**Inc GST**  
**\$19.80**

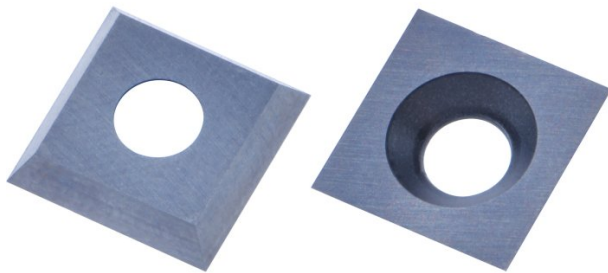

ORDER CODE:	W30485
MODEL:	~
Type:	Square Carbide Insert
No. of Piece:	2
Thread Size:	~
D:	~
L (mm):	11
W (mm):	11
T (mm):	2
a (deg):	30°
Suits:	Wood Turning Tools - Insert Type

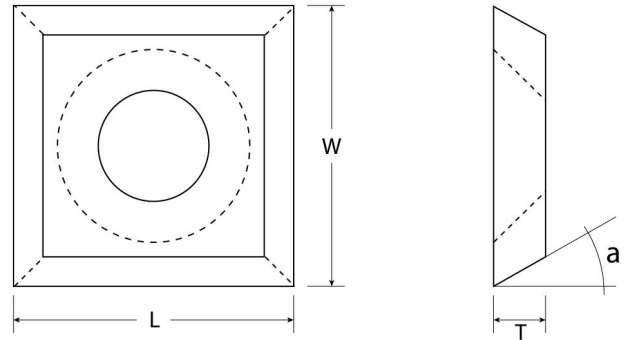

## Description

Replacement square tungsten carbide inserts are designed to suit carbide woodturning chisels. Ideal for roughing, shaping and general-purpose turning, this durable cutter provides a long service life and delivers a clean, smooth finish on a wide range of timbers.

Unlike traditional HSS tools, the carbide insert requires no sharpening. Simply rotate the cutter to a fresh edge when dull, extending tool life and reducing downtime. When all cutting edges have been used, replace the insert and continue turning.

## Features

- Square tungsten carbide insert
- Suits carbide woodturning chisel sets
- Four usable cutting edges for extended life
- Produces a smooth, clean finish
- No sharpening required
- Rotate cutter when dull for a fresh cutting edge
- Ideal for roughing, shaping and general turning applications
- Supplied as a convenient 2-piece pack

## Includes

- 2 Piece Pack

Product Brochure For W30485

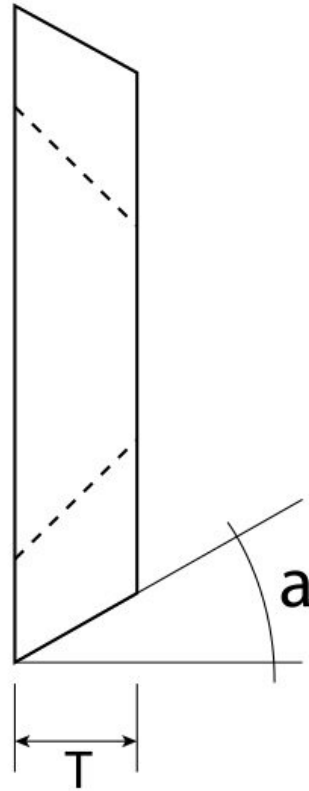
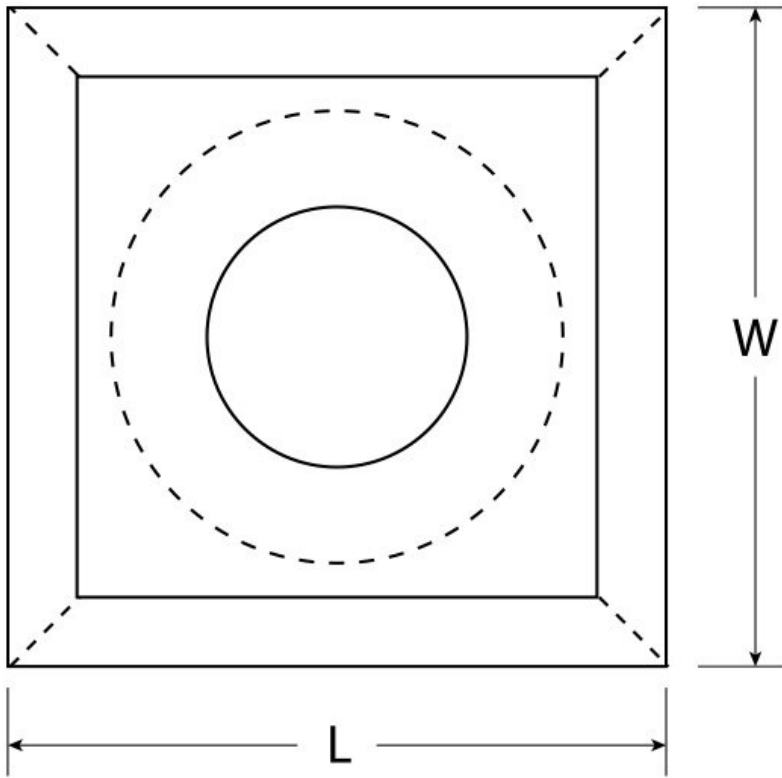

**Specific Features**

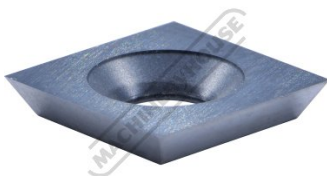

Low View

Product Brochure For W30485

---

**Recommended Accessories**

W30494

M4 - Torx Head Screw



W3045

Wood Turning Set - 3 Piece



W3046

Wood Turning Set - 4 Piece

